

Weiller®



OCAK 2022 FİYAT LİSTESİ

ÇÖZÜM ORTAKLARIMIZ



*Bu fiyat listesindeki tipografik baskı hatalarından firmamız sorumlu değildir.

*Firmamız fiyat listesinde yayınlamış olduğu teknik özellikleri değiştirme, döviz ve hammadde artışlarından dolayı meydana gelebilecek fiyat artışlarını hiçbir uyarıda bulunmaksızın fiyat listesine yansıtma hakkına sahiptir.

*Listedeki fiyatlara KDV dahil değildir.

İÇİNDEKİLER				SAYFA NO	İÇİNDEKİLER				SAYFA NO
WL5 SERİSİ BUTONLAR				4-5	Ø16-19-22mm METAL BUTONLAR				37-40
WL9 SERİSİ BUTONLAR				6-7-8-9	Ø16mm PLASTİK BUTONLAR				41
LAY2 SERİSİ BUTONLAR				10	ANAHTAR GRUPLARI				42-45
HQ SERİSİ BUTONLAR				11	PORSELEN SİĞORTALAR				46-47
JOYSTICK POTLAR				12	RÖLE ve SOKETLER				48-49
BUZZER ve SİRENLER				13	LED TRAFOSU ve GÜÇ KAYNAKLARI				50-51
SİNYAL ve LEDLER				14	PANO GRUPLARI				52
VOLTMETRE AMPERMETRE SİNYAL LAMBALAR				15	FANLAR				53
ROZETLER - ETİKET ve KORUMA KAPAKLARI				16	İZOLELİ İZOLELİSİZ PABUÇLAR				54-55
TEKLİ KUTULU MONTAJLI ÜRÜNLER ve PAKOLAR				17	SKP KABLO PABUÇLARI				56-57
BOŞ KUMANDA ve BUTON KILIFLARI				18-19	EK MUF ve BARALAR				58
ASANSÖR GRUBU MONTAJLI ÜRÜNLER				20-21	İÇİ YAPIŞKANLI DARALAN CAM ELYAF ÇORAPLAR				59-61
VİNÇ KUMANDALAR				22	KABLO BAĞLANTI ELEMANLARI				62-64
ARAÇ LİFT KUMANDALAR				23	TOPRAKLAMA KLEMENSLER DAĞITICI ÜNİTELER				66-67
AYAK PEDALLARI				25	İLX IŞIKLI BUZZERLİ KUTULAR				68-72
KONTROL PANELLERİ PEDALLAR				26-27	ETİKETLER LEVHALAR				74-77
XCK SERİSİ LİMİT SWITCHLER				28	UNIT ÖLÇÜ ALETLERİ				80-88
CSA ve CWL SERİSİ LİMİT SWITCHLER				29	WEILLER EL ALETLERİ				89-91
T2 SERİSİ LİMİT SWITCHLER XV MICRO SWITCH				30	ŞAFAK EL ALETLERİ				92-93
X2 SERİSİ MINI SWITCHLER XT TOGGLE SWITCHLER				31	STEINEL JONARDTOOLS STEWELD JOKARI KRAFTGRIP ORBIS WTOOLS				94-96
22M16 SERİSİ BUTONLAR				32-33					95-103
Ø16mm PLASTİK BUTONLAR				34-35					
Ø16mm PLASTİK BUTONLAR				36	HAVYA, LEHİM, PASTA SİLİKON TABANCASI				104-105

WL5 SERİSİ PLASTİK YAYLI BUTONLAR



KOD	ÖZELLİK	KONTAK	RENK	PKT ADEDİ	FİYAT / ADET
WL5-AA11	Ø22mm. Plastik Yaylı Start Butonu	1NO	⊖	10	\$3,90
WL5-AA21	Ø22mm. Plastik Yaylı Start Butonu	1NO	●	10	\$3,90
WL5-AA31	Ø22mm. Plastik Yaylı Start Butonu	1NO	●	10	\$3,90
WL5-AA51	Ø22mm. Plastik Yaylı Start Butonu	1NO	●	10	\$3,90
WL5-AA61	Ø22mm. Plastik Yaylı Start Butonu	1NO	●	10	\$3,90
WL5-AA42	Ø22mm. Plastik Yaylı Stop Butonu	1NC	●	10	\$3,90

WL5 SERİSİ PLASTİK İŞARETLİ ve YAYLI BUTONLAR



KOD	ÖZELLİK	KONTAK	RENK	PKT ADEDİ	FİYAT / ADET
WL5-AA3311	Ø22mm. Plastik İşaretili Yaylı Start Butonu	1NO	↑	10	\$4,20
WL5-AA4322	Ø22mm. Plastik İşaretili Yaylı Stop Butonu	1NC	⊖	10	\$4,20
WL5-AA3341	Ø22mm. Plastik İşaretili Yaylı Start Butonu	1NO	↑	10	\$4,20
WL5-AA3351	Ø22mm. Plastik İşaretili Yaylı Start Butonu	1NO	↓	10	\$4,20
WL5-AA5111	Ø22mm. Plastik İşaretili Yaylı Start Butonu	1NO	↓	10	\$4,20
WL5-AA3361	Ø22mm. Plastik İşaretili Yaylı Start Butonu	1NO	↓	10	\$4,20

WL5 SERİSİ PLASTİK İKİZ BUTONLAR



KOD	ÖZELLİK	KONTAK	RENK	PKT ADEDİ	FİYAT / ADET
WL5-AL7325	Ø22mm Plastik İkiz Buton	1NO/1NC	●/●	10	\$7,90
WL5-AW7465L	Ø22mm Plastik İkiz Buton Ledli 220VAC	1NO/1NC	●/●	10	\$11,20
WL5-AW7465-24L	Ø22mm Plastik İkiz Buton Ledli 24VAC/DC	1NO/1NC	●/●	10	\$11,20

WL5 SERİSİ PLASTİK MANTAR ACİL STOP



KOD	ÖZELLİK	KONTAK	PKT ADEDİ	FİYAT / ADET
WL5-AS542	Ø22mm Plastik Mantar Acil Stop Buton	1NC	10	\$5,90
WL5-AS542NO	Ø22mm Plastik Mantar Acil Stop Buton	1NO	10	\$5,90

WL5 SERİSİ PLASTİK MANTAR KAYICI BUTONLAR



KOD	ÖZELLİK	KONTAK	RENK	PKT ADEDİ	FİYAT / ADET
WL5-AC42	Ø22mm Plastik Kayıcı (Yaylı) Mantar Buton	1NC	●	10	\$5,90
WL5-AC31	Ø22mm Plastik Kayıcı (Yaylı) Mantar Buton	1NO	●	10	\$5,90
WL5-AC21	Ø22mm Plastik Kayıcı (Yaylı) Mantar Buton	1NO	●	10	\$5,90

WL5 SERİSİ PLASTİK KALICI ve KAYICI MANDAL BUTONLAR



KOD	ÖZELLİK	KONTAK	PKT ADEDİ	FİYAT / ADET
WL5-AD21	Ø22mm Plastik (0-1) Kalıcı Mandal Buton	1NO	10	\$5,30
WL5-AD33	Ø22mm Plastik (1-0-2) Kalıcı Mandal Buton	1NO/1NO	10	\$7,50
WL5-AD41	Ø22mm Plastik (0-1) Kayıcı (Yaylı) Mandal Buton	1NO	10	\$6,00
WL5-AD53	Ø22mm Plastik (1-0-2) Kayıcı (Yaylı) Mandal Buton	1NO/1NO	10	\$7,90

WL5 SERİSİ PLASTİK KALICI ANAHTARLI BUTONLAR

KOD	ÖZELLİK	KONTAK	PKT ADEDİ	FİYAT / ADET
WL5-AG21	Ø22mm Plastik (0-1) Kalıcı Anahtarlı Buton	1NO	10	\$11,20
WL5-AG33	Ø22mm Plastik (1-0-2) Kalıcı Anahtarlı Buton	1NO/1NO	10	\$12,70



WL5 SERİSİ PLASTİK LED IŞIKLI YAYLI BUTONLAR

KOD	ÖZELLİK	KONTAK	RENK	PKT ADEDİ	FİYAT / ADET
WL5-AW3175	Ø22mm Plastik Ledli Yaylı Start Buton 110-240VAC	1NO	White	10	\$9,90
WL5-AW3375	Ø22mm Plastik Ledli Yaylı Start Buton 110-240VAC	1NO	Green	10	\$9,90
WL5-AW3475	Ø22mm Plastik Ledli Yaylı Stop Buton 110-240VAC	1NC	Red	10	\$9,90
WL5-AW3575	Ø22mm Plastik Ledli Yaylı Start Buton 110-240VAC	1NO	Yellow	10	\$9,90
WL5-AW3675	Ø22mm Plastik Ledli Yaylı Start Buton 110-240VAC	1NO	Blue	10	\$9,90



WL5 SERİSİ PLASTİK LED IŞIKLI YAYLI BUTONLAR

KOD	ÖZELLİK	KONTAK	RENK	PKT ADEDİ	FİYAT / ADET
WL5-AW3175-24	Ø22mm Plastik Ledli Yaylı Start Buton 10-30VAC-DC	1NO	White	10	\$9,90
WL5-AW3375-24	Ø22mm Plastik Ledli Yaylı Start Buton 10-30VAC-DC	1NO	Green	10	\$9,90
WL5-AW3475-24	Ø22mm Plastik Ledli Yaylı Stop Buton 10-30VAC-DC	1NC	Red	10	\$9,90
WL5-AW3575-24	Ø22mm Plastik Ledli Yaylı Start Buton 10-30VAC-DC	1NO	Yellow	10	\$9,90
WL5-AW3675-24	Ø22mm Plastik Ledli Yaylı Start Buton 10-30VAC-DC	1NO	Blue	10	\$9,90



WL5 SERİSİ PLASTİK LED IŞIKLI KALICI MANDAL BUTONLAR

KOD	ÖZELLİK	KONTAK	RENK	PKT ADEDİ	FİYAT / ADET
WL5-AK-123L	Ø22mm 0-1 Kalıcı Ledli Mandal Buton 240VAC	1NO	Green	10	\$14,30
WL5-AK-124L	Ø22mm 0-1 Kalıcı Ledli Mandal Buton 240VAC	1NC	Red	10	\$14,30
WL5-AK-123L-24	Ø22mm 0-1 Kalıcı Ledli Mandal Buton 10-30VAC/DC	1NO	Green	10	\$14,30
WL5-AK-124L-24	Ø22mm 0-1 Kalıcı Ledli Mandal Buton 10-30VAC/DC	1NC	Red	10	\$14,30



WL5 SERİSİ PLASTİK LED IŞIKLI KALICI MANDAL BUTONLAR

KOD	ÖZELLİK	KONTAK	RENK	PKT ADEDİ	FİYAT / ADET
WL5-AK-323L	Ø22mm 1-0-2 Kalıcı Ledli Mandal Buton 240VAC	1NO/1NO	Green	10	\$16,50
WL5-AK-324L	Ø22mm 1-0-2 Kalıcı Ledli Mandal Buton 240VAC	1NC/1NC	Red	10	\$16,50
WL5-AK-323L-24	Ø22mm 1-0-2 Kalıcı Ledli Mandal Buton 10-30VAC-DC	1NO/1NO	Green	10	\$16,50
WL5-AK-324L-24	Ø22mm 1-0-2 Kalıcı Ledli Mandal Buton 10-30VAC-DC	1NC/1NC	Red	10	\$16,50



YEDEK KONTAK BLOK

KOD	ÖZELLİK	KONTAK	RENK	PKT ADEDİ	FİYAT / ADET
WL5-BE101	1NO Start Yedek Kontak Bloğu	1NO	Green	50	\$1,95
WL5-BE102	1NC Stop Yedek Kontak Bloğu	1NC	Red	50	\$1,95
WL5- P.LED	P.Led Kontak Bloğu. (...'lı Bölüm İçin Renk ve Voltaj Belirtin.)		Yellow, Red, Green	10	\$3,90





WL9 SERİSİ PLASTİK YAYLI BUTONLAR

KOD	ÖZELLİK	KONTAK	RENK	PKT ADEDİ	FİYAT / ADET
WL9-AA11	Ø22mm. Plastik Yaylı Start Butonu	1NO	⊘	10	\$2,90
WL9-AA21	Ø22mm. Plastik Yaylı Start Butonu	1NO	●	10	\$2,90
WL9-AA31	Ø22mm. Plastik Yaylı Start Butonu	1NO	●	10	\$2,90
WL9-AA51	Ø22mm. Plastik Yaylı Start Butonu	1NO	●	10	\$2,90
WL9-AA61	Ø22mm. Plastik Yaylı Start Butonu	1NO	●	10	\$2,90
WL9-AA42	Ø22mm. Plastik Yaylı Stop Butonu	1NC	●	10	\$2,90



WL9 SERİSİ PLASTİK İŞARETLİ YAYLI BUTONLAR

KOD	ÖZELLİK	KONTAK	RENK	PKT ADEDİ	FİYAT / ADET
WL9-AA3341	Ø22mm. Plastik İşaretli Yaylı Start Butonu	1NO	ⓘ	10	\$3,10
WL9-AA3351	Ø22mm. Plastik İşaretli Yaylı Start Butonu	1NO	Ⓢ	10	\$3,10
WL9-AA3361	Ø22mm. Plastik İşaretli Yaylı Start Butonu	1NO	Ⓢ	10	\$3,10
WL9-AA4322	Ø22mm. Plastik İşaretli Yaylı Stop Butonu	1NC	Ⓢ	10	\$3,10
WL9-AA3371	Ø22mm. Plastik İşaretli Yaylı Start Butonu	1NO	Ⓢ	10	\$3,10
WL9-AA3381	Ø22mm. Plastik İşaretli Yaylı Start Butonu	1NO	Ⓢ	10	\$3,10



WL9 SERİSİ PLASTİK İKİZ BUTONLAR

KOD	ÖZELLİK	KONTAK	PKT ADEDİ	FİYAT / ADET
WL9-AL7325	Ø22mm Plastik İkiz Buton	1NO+1NC	10	\$5,00
WL9-AW7465L	Ø22mm Ledli Plastik İkiz Buton 220VAC	1NO+1NC	10	\$8,60
WL9-AW7465-24L	Ø22mm Ledli Plastik İkiz Buton 24VAC-DC	1NO+1NC	10	\$8,60
WL9-AL7425	Ø22mm Plastik İşaretli İkiz Buton	1NO+1NC	10	\$5,30
WL9-AW7425L	Ø22mm Ledli Plastik İşaretli İkiz Buton 220VAC	1NO+1NC	10	\$8,80
WL9-AW7425-24L	Ø22mm Ledli Plastik İşaretli İkiz Buton 24VAC-DC	1NO+1NC	10	\$8,80
WL9-AL7525	Ø22mm Plastik Yazılı İkiz Buton	1NO+1NC	10	\$5,30
WL9-AW7525L	Ø22mm Ledli Plastik Yazılı İkiz Buton 220VAC	1NO+1NC	10	\$8,80
WL9-AW7525-24L	Ø22mm Ledli Plastik Yazılı İkiz Buton 24VAC-DC	1NO+1NC	10	\$8,80
WL9-AL4151	Ø22mm Plastik Yukarı - Aşağı Oklu İkiz Buton	1NO+1NO	10	\$5,30
WL9-AL4252	Ø22mm Plastik Yukarı - Aşağı Oklu Ters Yönlü İkiz Buton	1NO+1NO	10	\$5,30
WL9-AL6171	Ø22mm Plastik Alarm - Ortak Oklu İkiz Buton	1NO+1NO	10	\$5,30
WL9-AL7181	Ø22mm Plastik Alarm - Lamba İkiz Buton	1NO+1NO	10	\$5,30
WL9-AL6181	Ø22mm Plastik Lamba - Ortak Oklu İkiz Buton	1NO+1NO	10	\$5,30
WL9-AL4353	Ø22mm Plastik İşaretli Start+Start İkiz Buton	1NO+1NO	10	\$5,30



WL9 SERİSİ PLASTİK KALICI ve KAYICI MANDAL BUTONLAR

KOD	ÖZELLİK	KONTAK	PKT ADEDİ	FİYAT / ADET
WL9-AD21	Ø22mm Plastik (0-1) Kalıcı Mandal Buton	1NO	10	\$3,10
WL9-AD33	Ø22mm Plastik (1-0-2) Kalıcı Mandal Buton	1NO+1NO	10	\$4,60
WL9-AD41	Ø22mm Plastik (0-1) Kayıcı (Yaylı) Mandal Buton	1NO	10	\$3,20
WL9-AD53	Ø22mm Plastik (1-0-2) Kayıcı (Yaylı) Mandal Buton	1NO+1NO	10	\$4,70

WL9 SERİSİ PLASTİK MANTAR ACİL STOP BUTONLAR

KOD	ÖZELLİK	KONTAK	RENK	PKT ADEDİ	FİYAT / ADET
WL9-AS542	Ø40mm Plastik Kafa Mantar Acil Stop Buton	1NC	●	10	\$3,90
WL9-AS542E	Ø40mm Plastik Kafa Mantar Acil Stop Etiketli Buton	1NC	●	10	\$4,80
WL9-AS511	Ø40mm Plastik Kafa Mantar Start Buton	1NO	●	10	\$4,10
WL9-AS142	Ø40mm Plastik Kafa Anahtarlı Mantar Acil Stop Buton	1NC	●	10	\$8,60
WL9-AS442	Ø30mm Plastik Kafa Mantar Acil Stop Buton	1NC	●	10	\$4,10
WL9-AS542NO	Ø40mm Plastik Kafak Mantar Acil Start Buton	1NO	●	10	\$3,90



WL9 SERİSİ PLASTİK MANTAR ACİL STOP BUTONLAR

KOD	ÖZELLİK	KONTAK	RENK	PKT ADEDİ	FİYAT / ADET
WL9-AC31	Ø22 mm Plastik Kayıcı Mantar Buton	1NO	●	10	\$3,90
WL9-AC51	Ø22 mm Plastik Kayıcı Mantar Buton	1NO	●	10	\$4,80
WL9-AC42	Ø22 mm Plastik Kayıcı Mantar Buton	1NC	●	10	\$4,10



AC51

AC42



WL9 SERİSİ PLASTİK LED IŞIKLI YAYLI BUTONLAR

KOD	ÖZELLİK	KONTAK	RENK	PKT ADEDİ	FİYAT / ADET
WL9-AW3375	Ø22mm Plastik Ledli Yaylı Start Buton 240VAC	1NO	●	10	\$5,90
WL9-AW3575	Ø22mm Plastik Ledli Yaylı Stop Buton 240VAC	1NO	●	10	\$5,90
WL9-AW3675	Ø22mm Plastik Ledli Yaylı Start Buton 240VAC	1NO	●	10	\$5,90
WL9-AW3475	Ø22mm Plastik Ledli Yaylı Start Buton 240VAC	1NC	●	10	\$5,90
WL9-AW3375-24	Ø22mm Plastik Ledli Yaylı Start Buton 24VAC-DC	1NO	●	10	\$5,90
WL9-AW3575-24	Ø22mm Plastik Ledli Yaylı Stop Buton 24VAC-DC	1NO	●	10	\$5,90
WL9-AW3675-24	Ø22mm Plastik Ledli Yaylı Start Buton 24VAC-DC	1NO	●	10	\$5,90
WL9-AW3475-24	Ø22mm Plastik Ledli Yaylı Start Buton 24VAC-DC	1NC	●	10	\$5,90



AW3675

AW3475



WL9 SERİSİ 0-1 PLASTİK LED IŞIKLI KALICI MANDAL BUTONLAR

KOD	ÖZELLİK	KONTAK	RENK	PKT ADEDİ	FİYAT / ADET
WL9-AK123L	Ø22mm 0-1 Kalıcı Ledli Mandal Buton 240VAC	1NO	●	10	\$7,50
WL9-AK124L	Ø22mm 0-1 Kalıcı Ledli Mandal Buton 240VAC	1NC	●	10	\$7,50
WL9-AK125L	Ø22mm 0-1 Kalıcı Ledli Mandal Buton 240VAC	1NO	●	10	\$7,50
WL9-AK123-24L	Ø22mm 0-1 Kalıcı Ledli Mandal Buton 10-30VAC-DC	1NO	●	10	\$7,50
WL9-AK124-24L	Ø22mm 0-1 Kalıcı Ledli Mandal Buton 10-30VAC-DC	1NC	●	10	\$7,50
WL9-AK125-24L	Ø22mm 0-1 Kalıcı Ledli Mandal Buton 10-30VAC-DC	1NO	●	10	\$7,50

AK123L



AK125L

AK124L



WL9 SERİSİ 1-0-2 PLASTİK LED IŞIKLI KALICI MANDAL BUTONLAR

KOD	ÖZELLİK	KONTAK	RENK	PKT ADEDİ	FİYAT / ADET
WL9-AK323L	Ø22mm 1-0-2 Kalıcı Ledli Mandal Buton 240VAC	1NO	●	10	\$8,70
WL9-AK324L	Ø22mm 1-0-2 Kalıcı Ledli Mandal Buton 240VAC	1NC	●	10	\$8,70
WL9-AK325L	Ø22mm 1-0-2 Kalıcı Ledli Mandal Buton 240VAC	1NO	●	10	\$8,70
WL9-AK323-24L	Ø22mm 1-0-2 Kalıcı Ledli Mandal Buton 10-30VAC-DC	1NO	●	10	\$8,70
WL9-AK324-24L	Ø22mm 1-0-2 Kalıcı Ledli Mandal Buton 10-30VAC-DC	1NC	●	10	\$8,70
WL9-AK325-24L	Ø22mm 1-0-2 Kalıcı Ledli Mandal Buton 10-30VAC-DC	1NO	●	10	\$8,70

AK323L



AK325L

AK324L



WL9 SERİSİ PLASTİK KALICI ve KAYICI ANAHTARLI BUTONLAR

KOD	ÖZELLİK	KONTAK	PKT ADEDİ	FİYAT / ADET
WL9-AG21	Ø22mm Plastik (0-1) Kalıcı Anahtarlı Buton	1NO	10	\$8,00
WL9-AG33	Ø22mm Plastik (1-0-2) Kalıcı Anahtarlı Buton	1NO/1NO	10	\$9,60
WL9-AG41	Ø22mm Plastik (0-1) Kayıcı (Yaylı) Anahtarlı Buton	1NO	10	\$8,20
WL9-AG53	Ø22mm Plastik (1-0-2) Kayıcı (Yaylı) Anahtarlı Buton	1NO/1NO	10	\$10,00



WL9 SERİSİ METAL KAPLAMALI YAYLI BUTONLAR



KOD	ÖZELLİK	KONTAK	RENK	PKT ADEDİ	FİYAT / ADET
WL9-BA11	Ø22mm. Metal Kaplamalı Yaylı Start Butonu	1NO	White	10	\$3,10
WL9-BA21	Ø22mm. Metal Kaplamalı Yaylı Start Butonu	1NO	Black	10	\$3,10
WL9-BA31	Ø22mm. Metal Kaplamalı Yaylı Start Butonu	1NO	Green	10	\$3,10
WL9-BA51	Ø22mm. Metal Kaplamalı Yaylı Start Butonu	1NO	Yellow	10	\$3,10
WL9-BA61	Ø22mm. Metal Kaplamalı Yaylı Start Butonu	1NO	Blue	10	\$3,10
WL9-BA42	Ø22mm. Metal Kaplamalı Yaylı Stop Butonu	1NC	Red	10	\$3,10

WL9 SERİSİ METAL KAPLAMALI İŞARETLİ YAYLI BUTONLAR



KOD	ÖZELLİK	KONTAK	RENK	PKT ADEDİ	FİYAT / ADET
WL9-BA3341	Ø22mm. Metal Kaplamalı İşaretili Yaylı Start Butonu	1NO	White with I symbol	10	\$3,25
WL9-BA3351	Ø22mm. Metal Kaplamalı İşaretili Yaylı Start Butonu	1NO	Black with I symbol	10	\$3,25
WL9-BA3361	Ø22mm. Metal Kaplamalı İşaretili Yaylı Start Butonu	1NO	Blue with I symbol	10	\$3,25
WL9-BA4322	Ø22mm. Metal Kaplamalı İşaretili Yaylı Stop Butonu	1NC	Red with O symbol	10	\$3,25
WL9-BA3371	Ø22mm. Metal Kaplamalı İşaretili Yaylı Start Butonu	1NO	Yellow with I symbol	10	\$3,25
WL9-BA3381	Ø22mm. Metal Kaplamalı İşaretili Yaylı Start Butonu	1NO	White with I symbol	10	\$3,25

WL9 SERİSİ METAL KAPLAMALI İŞARETLİ ve İŞARETSİZ İKİZ BUTONLAR



KOD	ÖZELLİK	KONTAK	RENK	PKT ADEDİ	FİYAT / ADET
WL9-BL7325	Ø22mm Metal Kaplamalı İkiz Buton	1NO/1NC	Green/Red	10	\$5,50
WL9-BW7465L	Ø22mm Ledli Metal Kaplamalı İkiz Buton 220VAC	1NO/1NC	Green/Red	10	\$9,60
WL9-BW7465-24L	Ø22mm Ledli Metal Kaplamalı İkiz Buton 24VAC-DC	1NO/1NC	Green/Red	10	\$9,60
WL9-BL7425	Ø22mm Metal Kaplamalı İşaretili İkiz Buton	1NO/1NC	Green/Red with I/O symbols	10	\$5,90
WL9-BW7425L	Ø22mm Ledli Metal Kaplamalı İşaretili İkiz Buton 220VAC	1NO/1NC	Green/Red with I/O symbols	10	\$9,90
WL9-BW7425-24L	Ø22mm Ledli Metal Kaplamalı İşaretili İkiz Buton 24VAC-DC	1NO/1NC	Green/Red with I/O symbols	10	\$9,90
WL9-BL7525	Ø22mm Metal Kaplamalı Yazılı İkiz Buton	1NO/1NC	Green/Red with text	10	\$5,90
WL9-BW7525L	Ø22mm Ledli Metal Kaplamalı Yazılı İkiz Buton 220VAC	1NO/1NC	Green/Red with text	10	\$9,90
WL9-BW7525-24L	Ø22mm Ledli Metal Kaplamalı Yazılı İkiz Buton 24VAC-DC	1NO/1NC	Green/Red with text	10	\$9,90
WL9-BL4151	Ø22mm Metal Kaplamalı Yukarı - Aşağı Oklu İkiz Buton	1NO/1NO	White/Black with I/O symbols	10	\$6,00
WL9-BL4252	Ø22mm Metal Kaplamalı Yukarı - Aşağı Oklu Ters Yönlü İkiz Buton	1NO/1NO	White/Black with I/O symbols	10	\$6,00
WL9-BL6171	Ø22mm Metal Kaplamalı Alarm - Ortak Oklu İkiz Buton	1NO/1NO	Yellow/Blue with alarm symbol	10	\$6,00
WL9-BL7181	Ø22mm Metal Kaplamalı Alarm - Lamba İkiz Buton	1NO/1NO	Yellow/Blue with alarm symbol	10	\$6,00
WL9-BL6181	Ø22mm Metal Kaplamalı Lamba - Ortak Oklu İkiz Buton	1NO/1NO	White/Blue with alarm symbol	10	\$6,00
WL9-BL4353	Ø22mm Metal Kaplamalı Start+Start İşaretili İkiz Buton	1NO/1NO	White/Black with I/O symbols	10	\$6,00

WL9 SERİSİ METAL KAPLAMALI KALICI ve KAYICI MANDAL BUTONLAR



KOD	ÖZELLİK	KONTAK	PKT ADEDİ	FİYAT / ADET
WL9-BD21	Ø22mm Plastik Metal Kaplamalı (0-1) Kalıcı Mandal Buton	1NO	10	\$3,30
WL9-BD33	Ø22mm Plastik Metal Kaplamalı (1-0-2) Kalıcı Mandal Buton	1NO/1NO	10	\$5,10
WL9-BD41	Ø22mm Plastik Metal Kaplamalı (0-1) Kayıcı (Yaylı) Mandal Buton	1NO	10	\$3,60
WL9-BD53	Ø22mm Plastik Metal Kaplamalı (1-0-2) Kayıcı (Yaylı) Mandal Buton	1NO/1NO	10	\$5,30

WL9 SERİSİ METAL KAPLAMALI MANTAR ACİL STOP BUTONLAR					
KOD	ÖZELLİK	KONTAK	RENK	PKT ADEDİ	FİYAT / ADET
WL9-BS542	Ø40mm Plastik Kafa Metal Kaplamalı Mantar Acil Stop Buton	1NC	●	10	\$4,40
WL9-BS542E	Ø40mm Plastik Kafa Metal Kaplamalı Mantar Acil Stop Etiketli Buton	1NC	●	10	\$5,20
WL9-BS511	Ø40mm Plastik Kafa Metal Kaplamalı Mantar Start Buton	1NO	●	10	\$4,50
WL9-BS142	Ø40mm Plastik Kafa Metal Kaplamalı Anahtarlı Mantar Acil Stop Buton	1NC	●	10	\$9,60
WL9-BS442	Ø30mm Plastik Kafa Metal Kaplamalı Mantar Acil Stop Buton	1NC	●	10	\$4,80
WL9-BS542NO	Ø40mm Plastik Kafa Metal Kaplamalı Mantar Acil Start Buton	1NO	●	10	\$4,40



WL9 SERİSİ METAL KAPLAMALI LED IŞIKLI YAYLI BUTONLAR					
KOD	ÖZELLİK	KONTAK	RENK	PKT ADEDİ	FİYAT / ADET
WL9-BW3375	Ø22mm Metal Kaplamalı Ledli Yaylı Buton 240VAC	1NO	●	10	\$6,50
WL9-BW3575	Ø22mm Metal Kaplamalı Ledli Yaylı Buton 240VAC	1NO	●	10	\$6,50
WL9-BW3675	Ø22mm Metal Kaplamalı Ledli Yaylı Buton 240VAC	1NO	●	10	\$6,50
WL9-BW3475	Ø22mm Metal Kaplamalı Ledli Yaylı Buton 240VAC	1NC	●	10	\$6,50



WL9 SERİSİ METAL KAPLAMALI LED IŞIKLI YAYLI BUTONLAR					
KOD	ÖZELLİK	KONTAK	RENK	PKT ADEDİ	FİYAT / ADET
WL9-BW3375-24	Ø22mm Plastik Metal Kaplamalı Ledli Yaylı Start Buton 24VAC-DC	1NO	●	10	\$6,50
WL9-BW3475-24	Ø22mm Plastik Metal Kaplamalı Ledli Yaylı Stop Buton 24VAC-DC	1NO	●	10	\$6,50
WL9-BW3575-24	Ø22mm Plastik Metal Kaplamalı Ledli Yaylı Start Buton 24VAC-DC	1NO	●	10	\$6,50
WL9-BW3675-24	Ø22mm Plastik Metal Kaplamalı Ledli Yaylı Start Buton 24VAC-DC	1NC	●	10	\$6,50



WL9 SERİSİ 0-1 METAL KAPLAMALI LEDLİ KALICI MANDAL BUTONLAR					
KOD	ÖZELLİK	KONTAK	RENK	PKT ADEDİ	FİYAT / ADET
WL9-BK123L	0-1 Metal Kaplamalı Ledli Kalıcı Mandal Buton 240VAC	1NO	●	10	\$8,20
WL9-BK124L	0-1 Metal Kaplamalı Ledli Kalıcı Mandal Buton 240VAC	1NC	●	10	\$8,20
WL9-BK125L	0-1 Metal Kaplamalı Ledli Kalıcı Mandal Buton 240VAC	1NO	●	10	\$8,20
WL9-BK123-24L	0-1 Metal Kaplamalı Ledli Kalıcı Mandal Buton 10-30VAC-DC	1NO	●	10	\$8,20
WL9-BK124-24L	0-1 Metal Kaplamalı Ledli Kalıcı Mandal Buton 10-30VAC-DC	1NC	●	10	\$8,20
WL9-BK125-24L	0-1 Metal Kaplamalı Ledli Kalıcı Mandal Buton 10-30VAC-DC	1NO	●	10	\$8,20



WL9 SERİSİ 1-0-2 METAL KAPLAMALI LEDLİ KALICI MANDAL BUTONLAR					
KOD	ÖZELLİK	KONTAK	RENK	PKT ADEDİ	FİYAT / ADET
WL9-BK323L	1-0-2 Metal Kaplamalı Ledli Kalıcı Mandal Buton 110-240VAC	1NO/1NO	●	10	\$9,50
WL9-BK324L	1-0-2 Metal Kaplamalı Ledli Kalıcı Mandal Buton 110-240VAC	1NC/1NC	●	10	\$9,50
WL9-BK325L	1-0-2 Metal Kaplamalı Ledli Kalıcı Mandal Buton 110-240VAC	1NO/1NO	●	10	\$9,50
WL9-BK323-24L	1-0-2 Metal Kaplamalı Ledli Kalıcı Mandal Buton 10-30VAC-DC	1NO/1NO	●	10	\$9,50
WL9-BK324-24L	1-0-2 Metal Kaplamalı Ledli Kalıcı Mandal Buton 10-30VAC-DC	1NC/1NC	●	10	\$9,50
WL9-BK325-24L	1-0-2 Ledli Kalıcı Mandal Buton 10-30VAC-DC	1NO/1NO	●	10	\$9,50



YEDEK KONTAK BLOK					
KOD	ÖZELLİK	KONTAK	RENK	PKT ADEDİ	FİYAT / ADET
WL9-BE101	1NO Start Yedek Kontak Bloğu	1NO	●	50	\$1,60
WL9-BE102	1NC Stop Yedek Kontak Bloğu	1NC	●	50	\$1,60
WL9-BE103-220...	Led Bloğu 220V AC *Lütfen Noktalı Yere Renk Belirtiniz		● ● ●	10	\$5,00
WL9-BE103-24...	Led Bloğu 24V AC *Lütfen Noktalı Yere Renk Belirtiniz		● ● ●	10	\$5,00



LAY2 SERİSİ Ø22mm PLASTİK YAYLI BUTONLAR



KOD	ÖZELLİK	KONTAK	RENK	PKT ADEDİ	FİYAT / ADET
LAY2-EA11	Ø22mm Plastik Yaylı Start Buton	1NO	⊘	20	\$1,70
LAY2-EA21	Ø22mm Plastik Yaylı Start Buton	1NO	●	20	\$1,70
LAY2-EA31	Ø22mm Plastik Yaylı Start Buton	1NO	●	20	\$1,70
LAY2-EA51	Ø22mm Plastik Yaylı Start Buton	1NO	●	20	\$1,70
LAY2-EA42	Ø22mm Plastik Yaylı Stop Buton	1NC	●	20	\$1,70

LAY2 SERİSİ Ø22mm PLASTİK İŞARETLİ YAYLI BUTONLAR



KOD	ÖZELLİK	KONTAK	RENK	PKT ADEDİ	FİYAT / ADET
LAY2-EA3341	Ø22mm Plastik İşaretlili Yaylı Start Buton	1NO	⊘	20	\$1,90
LAY2-EA3351	Ø22mm Plastik İşaretlili Yaylı Start Buton	1NO	●	20	\$1,90
LAY2-EA3361	Ø22mm Plastik İşaretlili Yaylı Start Buton	1NO	⊘	20	\$1,90
LAY2-EA3371	Ø22mm Plastik İşaretlili Yaylı Start Buton	1NO	●	20	\$1,90
LAY2-EA3381	Ø22mm Plastik İşaretlili Yaylı Start Buton	1NO	⊘	20	\$1,90

LAY2 SERİSİ Ø22mm PLASTİK KALICI MANDAL BUTONLAR



KOD	ÖZELLİK	KONTAK	PKT ADEDİ	FİYAT / ADET
LAY2-ED21	Ø22mm Plastik 0-1 Kalıcı Mandal Buton	1NO	20	\$2,00
LAY2-ED33	Ø22mm Plastik 1-0-2 Kalıcı Mandal Buton	1NO/1NO	20	\$2,90

LAY2 SERİSİ Ø22mm PLASTİK KAYICI (YAYLI) MANDAL BUTONLAR



KOD	ÖZELLİK	KONTAK	PKT ADEDİ	FİYAT / ADET
LAY2-ED41	Ø22mm Plastik (0-1) Kayıcı (Yaylı) Mandal Buton	1NO	20	\$2,40
LAY2-ED53	Ø22mm Plastik (1-0-2) Kayıcı (Yaylı) Mandal Buton	1NO/1NO	20	\$3,30

LAY2 SERİSİ Ø22mm PLASTİK KALICI ANAHTARLI BUTONLAR (Anahtar Her Konumda Çıkar)



KOD	ÖZELLİK	KONTAK	PKT ADEDİ	FİYAT / ADET
LAY2-EG41	Ø22mm Plastik (0-1) Kalıcı Anahtarlı Buton	1NO	20	\$3,65
LAY2-EG53	Ø22mm Plastik (1-0-2) Kalıcı Anahtarlı Buton	1NO/1NO	20	\$4,60

LAY2 SERİSİ Ø22mm PLASTİK KAYICI (YAYLI) ANAHTARLI BUTONLAR



KOD	ÖZELLİK	KONTAK	PKT ADEDİ	FİYAT / ADET
LAY2-EG61	Ø22mm Plastik (0-1) Kayıcı (Yaylı) Anahtarlı Buton	1NO	20	\$3,70
LAY2-EG73	Ø22mm Plastik (1-0-2) Kayıcı (Yaylı) Anahtarlı Buton	1NO/1NO	20	\$4,60

LAY2 SERİSİ Ø40mm PLASTİK YAYLI ANAHTARLI BUTONLAR



KOD	ÖZELLİK	KONTAK	PKT ADEDİ	FİYAT / ADET
LAY2-ES542	Ø40mm Plastik Kafa Acil Stop (EMERGENCY) Butonu	1NC	20	\$3,20
LAY2-ES542NO	Ø40mm Plastik Kafa Acil Start (EMERGENCY) Butonu	1NO	20	\$3,20
LAY2-ES542E	Ø40mm Plastik Kafa Etiketli Acil Stop (EMERGENCY) Butonu	1NC	20	\$3,50
LAY2-ES442	Ø30mm Plastik Kafa Acil Stop (EMERGENCY) Butonu	1NC	20	\$3,50
LAY2-ES642	Ø40mm Plastik Kafa Pencereci Acil Stop (EMERGENCY) Butonu	1NC	20	\$4,20

YEDEK KONTAK BLOKLARI



KOD	ÖZELLİK	PKT ADEDİ	FİYAT / ADET
LAY2-BE101	1NO Start Yedek Kontak Bloğu	20	\$0,90
LAY2-BE102	1NC Stop Yedek Kontak Bloğu	20	\$0,90

HQ SERİSİ Ø22mm PLASTİK YAYLI BUTONLAR

KOD	ÖZELLİK	KONTAK	RENK	PKT ADEDİ	FİYAT / ADET
HQ-2110G	Ø22mm Plastik Yaylı Start Buton	1NO	●	10	\$3,70
HQ-2110Y	Ø22mm Plastik Yaylı Start Buton	1NO	●	10	\$3,70
HQ-2101R	Ø22mm Plastik Yaylı Stop Buton	1NC	●	10	\$3,70



HQ SERİSİ Ø22mm PLASTİK YAYLI BUTONLAR

KOD	ÖZELLİK	KONTAK	RENK	PKT ADEDİ	FİYAT / ADET
HQ-2111G	Ø22mm Plastik Yaylı Start Buton	1NO/1NC	●	10	\$5,30
HQ-2111Y	Ø22mm Plastik Yaylı Start Buton	1NO/ 1NC	●	10	\$5,30
HQ-2111R	Ø22mm Plastik Yaylı Stop Buton	1NO/ 1NC	●	10	\$5,30



HQ SERİSİ Ø22mm PLASTİK KALICI BUTONLAR

KOD	ÖZELLİK	KONTAK	RENK	PKT ADEDİ	FİYAT / ADET
HQ-3110G	Ø22mm Plastik Kalıcı Start Buton	1NO	●	10	\$4,30
HQ-3110Y	Ø22mm Plastik Kalıcı Start Buton	1NO	●	10	\$4,30
HQ-3101R	Ø22mm Plastik Kalıcı Stop Buton	1NC	●	10	\$4,30



***KALICI**

HQ SERİSİ Ø22mm PLASTİK KALICI BUTONLAR

KOD	ÖZELLİK	KONTAK	RENK	PKT ADEDİ	FİYAT / ADET
HQ-3111G	Ø22mm Plastik Kalıcı Start Buton	1NO/1NC	●	10	\$5,90
HQ-3111Y	Ø22mm Plastik Kalıcı Start Buton	1NO/ 1NC	●	10	\$5,90
HQ-3111R	Ø22mm Plastik Kalıcı Stop Buton	1NO/ 1NC	●	10	\$5,90



***KALICI**



HQ-22-01P



HQ-22-10P



HQ-22-S02P



HQ-22-S20P



HQ-22-S11P

YEDEK KONTAK BLOKLARI

KOD	ÖZELLİK	KONTAK	PKT ADEDİ	FİYAT / ADET
HQ-22-10P	Start Yedek Kontak Bloğu	1NO	10	\$1,60
HQ-22-01P	Stop Yedek Kontak Bloğu	1NC	10	\$1,60
HQ-22-S11P	Yedek Kontak Bloğu	1NO/1NC	10	\$2,90
HQ-22-S20P	Start Yedek Kontak Bloğu	2NO	10	\$2,90
HQ-22-S02P	Stop Yedek Kontak Bloğu	2NC	10	\$2,90



JOYSTICK KONTROL

KOD	ÖZELLİK	KONTAK	PKT ADEDİ	FİYAT / ADET
LAY5-PA22	Ø22mm 4 Yönlü Yaylı Joystick	1NO/1NO	10	\$18,50
LAY5-PA24	Ø22mm 4 Yönlü Yaylı Joystick	2NO/2NO	10	\$21,90



JOYSTICK KONTROL

KOD	ÖZELLİK	KONTAK	PKT ADEDİ	FİYAT / ADET
WL5-PA22	Ø22mm 2 Yönlü Yaylı Joystick	1NO/1NO	10	\$30,00
WL5-PA24	Ø22mm 4 Yönlü Yaylı Joystick	2NO/2NO	10	\$37,00
WL5-PA12	Ø22mm 2 Yönlü Kalıcı Joystick	1NO/1NO	10	\$31,00
WL5-PA14	Ø22mm 4 Yönlü Kalıcı Joystick	2NO/2NO	10	\$38,00

Ø22mm METAL KAPLAMALI POTANSİYOMETRE - TEK TUR -

KOD	ÖZELLİK	PKT ADEDİ	FİYAT / ADET
WL5-PT1K-M	Ø22mm Metal Kaplamalı Potansiyometre (1K)	10	\$11,80
WL5-PT2K-M	Ø22mm Metal Kaplamalı Potansiyometre (2K)	10	\$11,80
WL5-PT5K-M	Ø22mm Metal Kaplamalı Potansiyometre (5K)	10	\$11,80
WL5-PT10K-M	Ø22mm Metal Kaplamalı Potansiyometre (10K)	10	\$11,80
WL5-PT5K-MC	Ø22mm Metal Kaplamalı Potansiyometre - Seramik (Cermet) (5K)	10	\$14,70
WL5-PT10K-MC	Ø22mm Metal Kaplamalı Potansiyometre - Seramik (Cermet) (10K)	10	\$14,70

*TÜRK PATENT ve MARKA KURUMU 'TR2020 01097Y' Faydalı Model Patentine Sahiptir.



Ø22 mm LEDLİ BUZZER - 90dB

KOD	ÖZELLİK	RENK	PKT ADEDİ	FİYAT / ADET
WL22-220MSD	Ø22mm Sesli-Led Flaşör İkazlı 220VAC	●	10	\$4,70
WL22-24MSD	Ø22mm Sesli-Led Flaşör İkazlı 24VAC/DC	●	10	\$4,70
WL22-12MSD	Ø22mm Sesli-Led Flaşör İkazlı 12VAC/DC	●	10	\$5,20
WL22-24AY	Ø22mm Kabin İçi İkaz 24V DC	●	10	\$12,50



WL22-24AY

Ø30 mm SESLİ BUZZER - 105dB

KOD	ÖZELLİK	RENK	PKT ADEDİ	FİYAT / ADET
FM-220AA 901AF	Ø30 mm Tek Ses İkazlı 220VAC	●	20	\$13,50
FM-220AA 907AF	Ø30 mm Çift Ses İkazlı 220VAC	●	20	\$15,50
FM-24AA 901AF	Ø30 mm Tek Ses İkazlı 12 - 30VAC/DC	●	20	\$13,50
FM-24AA 907AF	Ø30 mm Çift Ses İkazlı 12 - 30VAC/DC	●	20	\$15,50



FM-...AA 901AF

NOT: Tek Ses İkazlar Kesik Tonlu, Çift Ses İkazlar Kesik ve Sürekli Tonludur.

Ø75mm ve Ø130mm MOTORLU SİRENLER - 90dB ve 110dB

KOD	ÖZELLİK	RENK	PKT ADEDİ	FİYAT / ADET
MS-190-220	Ø75 mm Motorlu Siren - Metal Gövde - 220VAC	●	1	\$23,00
MS-190-24	Ø75 mm Motorlu Siren - Metal Gövde - 24VAC/DC	●	1	\$23,00
MS-290-220	Ø130 mm Motorlu Siren - Metal Gövde - 220VAC	●	1	\$41,00
MS-290-24	Ø130 mm Motorlu Siren - Metal Gövde - 24VAC/DC	●	1	\$41,00



MS-190-...

Ø50 mm ve Ø90 mm ELEKTRONİK SİRENLER - 120/130 dB

KOD	ÖZELLİK	dB	PKT ADEDİ	FİYAT / ADET
ES-50-12/24	Elektronik Siren 12-24VAC/DC Plastik Gövde - 6 Ton	120 dB	1	\$7,30
ES-50-220	Elektronik Siren 220VAC Plastik Gövde	120 dB	1	\$8,20
ES-60-12	Elektronik Siren 12-24VAC/DC Plastik Gövde - 6 Ton	130 dB	1	\$9,60
ES-60-220	Elektronik Siren 220VAC Plastik Gövde	130 dB	1	\$11,50
E908-24	Elektronik Siren 12-24VAC/DC Ledli Plastik Gövde	120 dB	1	\$17,50
E908-220	Elektronik Siren 220VAC Ledli Plastik Gövde	120 dB	1	\$21,00
ES90-220	Elektronik Siren 220VAC Plastik Gövde	130dB	1	\$33,60



E908-...

ES-50-...

ES-60-...

ES-90-220



WL22 SERİSİ LEDLİ SİNYAL

KOD	ÖZELLİK	RENK	PKT ADEDİ	FİYAT / ADET
WL22-71	Ø22mm. Ledli Sinyal 200-260 VAC	●	10	\$1,50
WL22-73	Ø22mm. Ledli Sinyal 200-260 VAC	●	10	\$1,30
WL22-74	Ø22mm. Ledli Sinyal 200-260 VAC	●	10	\$1,30
WL22-75	Ø22mm. Ledli Sinyal 200-260 VAC	●	10	\$1,30
WL22-76	Ø22mm. Ledli Sinyal 200-260 VAC	●	10	\$1,50

KOD	ÖZELLİK	RENK	PKT ADEDİ	FİYAT / ADET
WL22-71-24	Ø22mm. Ledli Sinyal 24-30 VAC-DC	●	10	\$1,50
WL22-73-24	Ø22mm. Ledli Sinyal 24-30 VAC-DC	●	10	\$1,30
WL22-74-24	Ø22mm. Ledli Sinyal 24-30 VAC-DC	●	10	\$1,30
WL22-75-24	Ø22mm. Ledli Sinyal 24-30 VAC-DC	●	10	\$1,30
WL22-76-24	Ø22mm. Ledli Sinyal 24-30 VAC-DC	●	10	\$1,50



WL16 SERİSİ LEDLİ SİNYAL

KOD	ÖZELLİK	RENK	PKT ADEDİ	FİYAT / ADET
WL16-73	Ø16mm Ledli Sinyal 220 VAC	●	10	\$1,80
WL16-74	Ø16mm Ledli Sinyal 220 VAC	●	10	\$1,80
WL16-75	Ø16mm Ledli Sinyal 220 VAC	●	10	\$1,80

KOD	ÖZELLİK	RENK	PKT ADEDİ	FİYAT / ADET
WL16-73-24	Ø16mm Ledli Sinyal 24-30 VAC-DC	●	10	\$1,80
WL16-74-24	Ø16mm Ledli Sinyal 24-30 VAC-DC	●	10	\$1,80
WL16-75-24	Ø16mm Ledli Sinyal 24-30 VAC-DC	●	10	\$1,80



BA9S LED AMPUL

KOD	ÖZELLİK	RENK	PKT ADEDİ	FİYAT / ADET
BA9SL-220W	BA9S 220-240 VAC Led Ampul	●	50	\$2,00
BA9SL-220G	BA9S 220-240 VAC Led Ampul	●	50	\$1,70
BA9SL-220R	BA9S 220-240 VAC Led Ampul	●	50	\$1,70
BA9SL-220Y	BA9S 220-240 VAC Led Ampul	●	50	\$1,70
BA9SL-220B	BA9S 220-240 VAC Led Ampul	●	50	\$2,00

KOD	ÖZELLİK	RENK	PKT ADEDİ	FİYAT / ADET
BA9SL-110W	BA9S 110-130 VAC/DC Led Ampul	●	50	\$2,30
BA9SL-110G	BA9S 110-130 VAC/DC Led Ampul	●	50	\$2,10
BA9SL-110R	BA9S 110-130 VAC/DC Led Ampul	●	50	\$2,10
BA9SL-110Y	BA9S 110-130 VAC/DC Led Ampul	●	50	\$2,10
BA9SL-110B	BA9S 110-130 VAC/DC Led Ampul	●	50	\$2,30

KOD	ÖZELLİK	RENK	PKT ADEDİ	FİYAT / ADET
BA9SL-24W	BA9S 24-30 VAC/DC Led Ampul	●	50	\$2,00
BA9SL-24G	BA9S 24-30 VAC/DC Led Ampul	●	50	\$1,70
BA9SL-24R	BA9S 24-30 VAC/DC Led Ampul	●	50	\$1,70
BA9SL-24Y	BA9S 24-30 VAC/DC Led Ampul	●	50	\$1,70
BA9SL-24B	BA9S 24-30 VAC/DC Led Ampul	●	50	\$2,00

Ø22mm PLASTİK YUVARLAK VOLTMETRE

KOD	ÖZELLİK	RENK	PKT ADEDİ	FİYAT / ADET
WL22-VM73Y	Ø22mm. Display Göstergeli Voltmetre 12-500 VAC	●	10	\$4,70
WL22-VM74Y	Ø22mm. Display Göstergeli Voltmetre 12-500 VAC	●	10	\$4,70
WL22-VM75Y	Ø22mm. Display Göstergeli Voltmetre 12-500 VAC	●	10	\$4,70
WL22-VM74YDC	Ø22mm. Display Göstergeli Voltmetre 6-100 VDC	●	10	\$5,60



Ø22mm PLASTİK YUVARLAK AMPERMETRE

KOD	ÖZELLİK	RENK	PKT ADEDİ	FİYAT / ADET
WL22-VA73Y	Ø22mm Display Göstergeli Ampermetre 1A 100A AC MAX:380V Akım Trafolu	●	10	\$9,50
WL22-VA74Y	Ø22mm Display Göstergeli Ampermetre 1A 100A AC MAX:380V Akım Trafolu	●	10	\$9,50
WL22-VA75Y	Ø22mm Display Göstergeli Ampermetre 1A 100A AC MAX:380V Akım Trafolu	●	10	\$9,50



Ø22mm PLASTİK YUVARLAK TERMOMETRE

KOD	ÖZELLİK	RENK	PKT ADEDİ	FİYAT / ADET
WL22-TER74Y	Ø22mm Display Göstergeli Termometre 220V	●	10	\$12,30



Ø22mm PLASTİK YUVARLAK VOLTMETRE+AMPERMETRE

KOD	ÖZELLİK	RENK	PKT ADEDİ	FİYAT / ADET
WL22-VAM73Y	Ø22mm Display Göstergeli Voltmetre+Ampermetre 12-500 VAC 1A 100A AC Akım Trafolu	●	10	\$12,30
WL22-VAM74Y	Ø22mm Display Göstergeli Voltmetre+Ampermetre 12-500 VAC 1A 100A AC Akım Trafolu	●	10	\$12,30
WL22-VAM75Y	Ø22mm Display Göstergeli Voltmetre+Ampermetre 12-500 VAC 1A 100A AC Akım Trafolu	●	10	\$12,30



Ø8mm KROM KAPLAMALI LEDLİ SİNYAL

KOD	ÖZELLİK	RENK	PKT ADEDİ	FİYAT / ADET
WL8-71-24	Ø8 mm Krom Kaplamalı Sinyal 12-24VAC/DC	●	50	\$2,60
WL8-73-24	Ø8 mm Krom Kaplamalı Sinyal 12-24VAC/DC	●	50	\$2,60
WL8-74-24	Ø8 mm Krom Kaplamalı Sinyal 12-24VAC/DC	●	50	\$2,60
WL8-75-24	Ø8 mm Krom Kaplamalı Sinyal 12-24VAC/DC	●	50	\$2,60
WL8-76-24	Ø8 mm Krom Kaplamalı Sinyal 12-24VAC/DC	●	50	\$2,60



10mm PLASTİK SOMUNLU SİNYAL LAMBASI

KOD	ÖZELLİK	RENK	PKT ADEDİ	FİYAT / ADET
WLP10-73	10mm Plastik Somunlu Sinyal Lambası 220VAC	●	100	\$0,90
WLP10-74	10mm Plastik Somunlu Sinyal Lambası 220VAC	●	100	\$0,90
WLP10-75	10mm Plastik Somunlu Sinyal Lambası 220VAC	●	100	\$0,90
WLP10-73-24	10mm Plastik Somunlu Sinyal Lambası 24V DC	●	100	\$0,90
WLP10-74-24	10mm Plastik Somunlu Sinyal Lambası 24V DC	●	100	\$0,90
WLP10-75-24	10mm Plastik Somunlu Sinyal Lambası 24V DC	●	100	\$0,90





BUTON AKSESUARLARI

KOD	ÖZELLİK	PKT ADEDİ	FİYAT / ADET
WL5-BR1	Plastik Buton Rozeti *26 x 8 mm Camlı	100	\$0,42
WL5-BR2	Plastik Buton Rozeti *26 x 18 mm Camlı	100	\$0,46
WL5-BR3	Plastik Buton Rozeti *27 x 15mm Camlı	100	\$0,44
WL5-SCH-R1	Plastik Buton Rozeti *27 x 12 mm Camlı	80	\$0,50
WL5-SCH-R2	Plastik Buton Rozeti *27 x 18 mm Camlı	80	\$0,54
WL5-SİE-R	Plastik Buton Rozeti *27 x 12 mm Camsız	80	\$0,45
WL5-KTS (PG16)	Ø22mm Plastik Somunlu Kör Tapa *Renk Belirtiniz - Gri / Siyah	100	\$0,45
WL5-KTG (PG16)	Ø22mm Plastik Geçmeli Tip Kör Tapa *Renk Belirtiniz - Gri / Siyah	100	\$0,30

*Toptan Alışlarda Ambalaj Adetleri Geçerlidir.

ACİL STOP ETİKETLERİ

KOD	ÖZELLİK	PKT ADEDİ	FİYAT / ADET
WL5-ER60L	Ø60mm Leksan Baskılı Emergency Yapışkanlı Etiket	50	\$0,80
WL5-ER60LTR	Ø60mm Leksan Baskılı Acil Stop Yapışkanlı Etiket	50	\$0,80
WL5-ER60TE	Ø60mm Plastik Acil Durdurma + Emergency Rozeti (Kalın Tip) LAZER BASKI	50	\$0,55
WL5-ER60EN	Ø60mm Plastik Emergency Rozeti (Kalın Tip) LAZER BASKI	50	\$0,50
WL5-ER60TE-Y	Ø60mm Plastik Acil Durdurma + Emergency Rozeti - (İnce Tip) LAZER BASKI	50	\$0,45
WL5-ER60EN-Y	Ø60mm Plastik Emergency Rozeti - (İnce Tip) LAZER BASKI	50	\$0,45
WL5-ER60TR-Y	Ø60mm Plastik Acil Stop Rozeti - (İnce Tip) LAZER BASKI	50	\$0,45
WL5-ER60J2Y	Ø60mm Plastik İki Yönlü Joystick Rozeti - (İnce Tip) LAZER BASKI	50	\$0,70
WL5-ER60J4Y	Ø60mm Plastik Dört Yönlü Joystick Rozeti - (İnce Tip) LAZER BASKI	50	\$0,70
WL5-ER604L	Ø60mm Plastik Dört Dilde Acil Stop Rozeti - (İnce Tip) LAZER BASKI	50	\$0,80

*Toptan Alışlarda Ambalaj Adetleri Geçerlidir.



YAYLI BUTON KORUMA KILIF ve KAPAKLARI

KOD	ÖZELLİK	RENK	PKT ADEDİ	FİYAT / ADET
WL5-AP2	IP67 Buton Koruma Kılıfı *Yaylı Butonlar İçin (PVC)	ŞEFFAF	100	\$0,65
WL5-AP2-S	IP67 Silikon Buton Koruma Kılıfı *Yaylı Butonlar İçin (KAUÇUK SİLİKON)	ŞEFFAF	100	\$0,90
WL5-AP4	IP67 Yaylı Butonlar İçin WL9 Serisi İkiz Butonların Kılıfıdır	ŞEFFAF	20	\$1,30
WL5-ASP	Acil Stop Koruma Kapağı *Tam Kapaklı Mühürlü Tip		20	\$3,20
WL5-AKKM	Acil Stop Koruma Kapağı		20	\$0,90
WL5-AKK	Acil Stop Koruma Kapağı		20	\$0,80
WL5-AKKY	Acil Stop Koruma Kapağı		20	\$0,85
WL5-ASKK	Acil Stop Koruma Kapağı *Yarım Ay Şeklinde		20	\$3,20
WL5-MKK	Mandal Buton Koruma Kapağı		20	\$0,80
WL5-MKKY	Mandal Buton Koruma Kapağı		20	\$0,80

*Toptan Alışlarda Ambalaj Adetleri Geçerlidir.

BOŞ KUMANDA KUTULARI

KOD	ÖZELLİK	PKT ADEDİ	FİYAT / ADET
LAY5-BX01S	1'li Boş Kumanda Kutusu	6	\$2,50
LAY5-BX01SK	1'li Boş Kumanda Kutusu Korumalı	6	\$2,80
WL9-BX01S	1'li Boş Kumanda Kutusu	6	\$3,10
WL5-D101S	1'li Boş Alüminyum Buton Kutusu	1	\$4,50



KUTULU MONTAJLI ÜRÜNLER



WL9-KK31
1'li Kutulu Start Butonu 1NO
\$6,20



WL9-KK42
1'li Kutulu Stop Butonu 1NC
\$6,20



WL9-KK51
1'li Kutulu Start Butonu 1NO
\$6,20



WL9-BX71
1'li Kutulu Alarm Butonu 1NO
\$6,50



WL9-BX81
1'li Kutulu Aydınlatma Butonu 1NO
\$6,50



WL9-BX542
1'li Kutulu Acil Stop Butonu 1NC
\$7,60



WL9-BX542KAS
1'li Kutulu Plastik Korumalı
Acil Stop Butonu (Yeni Tip) 1NC
\$8,60



LAY5-BX542KES
1'li Kutulu Plastik Korumalı
Acil Stop Butonu (Eski Tip) 1NC
\$7,60



WL9-BX542KASP
1'li Kutulu Plastik Korumalı Pencereci
BasÇek Acil Stop Butonu 1NC
\$11,00



WL9-BX542ASP
1'li Kutulu Mühürlü Tip Korumalı
Acil Stop Butonu 1NC
\$11,50



WL5-DAK542E
1'li Kutulu Alüminyum Korumalı
Etiketli Acil Stop Butonu 1NC
\$38,00



WL9-BYP3K
1'li Kutulu 3 Kademe Bypass
Anahtarı
\$37,00



WL9-BX21
1'li Kutulu Plastik Korumalı
Revizyon Butonu
\$7,60



WL9-KANT
1'li Kutulu Kayıcı Reset Anahtarı
\$8,20



WL9-KBZ
1'li Kutulu Kabin Altı İkaz
Lambası - Buzzer'lı
\$9,50



WL5-RTP3x80
3x80A Ray Montaj Pako Şalter
\$31,00



WL5-RTP4x40
4x40A Ray Montaj Pako Şalter
\$32,00



WL5-RTP5x40
5x40A Ray Montaj Pako Şalter
\$35,00



WL5-RTP6x40
6x40A Ray Montaj Pako Şalter
\$39,00



WL5-RTP5x80
5x80A Ray Montaj Pako Şalter
\$42,00



PK01310S



PK01310K



PK102310S



PK102310K

KUTULU AÇ KAPA PAKO ŞALTER

KOD	ÖZELLİK	PKT ADEDİ	FİYAT / ADET
WL9-PK01110	Aç-Kapa Kutulu Pako Şalter 0-1 / 10A	3	\$14,50
WL9-PK01116	Aç-Kapa Kutulu Pako Şalter 0-1 / 16A	3	\$15,00
WL9-PK01125	Aç-Kapa Kutulu Pako Şalter 0-1 / 25A	3	\$21,50
WL9-PK01310	Aç-Kapa Kutulu Pako Şalter 0-1 / 3x10A	3	\$21,00
WL9-PK01316	Aç-Kapa Kutulu Pako Şalter 0-1 / 3x16A	3	\$22,90
WL9-PK01325	Aç-Kapa Kutulu Pako Şalter 0-1 / 3x25A	3	\$29,70

KUTULU KUTUP DEĞİŞTİRİCİ PAKO ŞALTER

KOD	ÖZELLİK	PKT ADEDİ	FİYAT / ADET
WL9-PK102110	Kutup Değiştirici Pako Şalter 1-0-2 / 10A	3	\$19,40
WL9-PK102116	Kutup Değiştirici Pako Şalter 1-0-2 / 16A	3	\$19,90
WL9-PK102125	Kutup Değiştirici Pako Şalter 1-0-2 / 25A	3	\$28,30
WL9-PK102310	Kutup Değiştirici Pako Şalter 1-0-2/3x10A	3	\$29,70
WL9-PK102316	Kutup Değiştirici Pako Şalter 1-0-2/3x16A	3	\$31,80
WL9-PK102325	Kutup Değiştirici Pako Şalter 1-0-2/3x25A	3	\$51,20

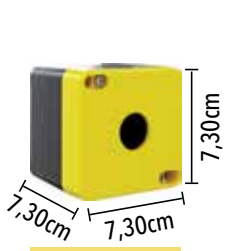

WL9-BX01S
\$3,10

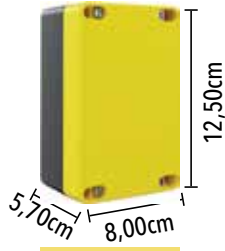

WL9-BB02S
\$4,40



WL9-BX02S
\$4,50



WL9-BX03SK
\$4,55



WL9-BX04SK
\$4,60

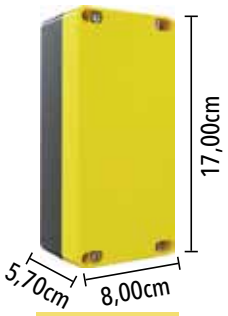

WL9-BB04S
\$5,50



WL9-BX03SO
\$5,60



WL9-BX04SO
\$5,65



WL9-BX05SO
\$5,70

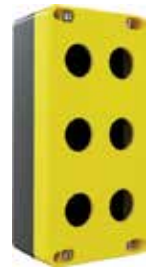

WL9-BX06SO
\$5,75

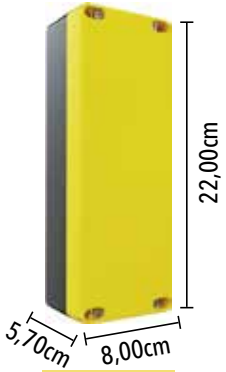

WL9-BB05S
\$6,80



WL9-BX05SB
\$6,90



WL9-BX06SB
\$6,95



WL9-BX07SB
\$7,00



WL9-BX08SB
\$7,05



WL9-BX10S
\$11,50

WL9-BXARA3

\$2,10

WL9-BXARA2

\$1,80

WL9-BXARA1

\$1,30

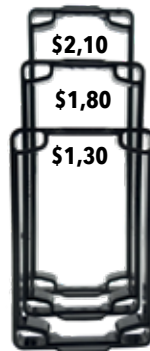

WL9-BX09S
\$10,80



BOŞ KUMANDA ve BUTON KUTULARI

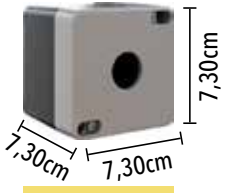

WL9-BX01G
\$3,10



WL9-BB02G
\$4,40



WL9-BX02G
\$4,50



WL9-BX03GK
\$4,55



WL9-BX04GK
\$4,60



WL9-BB04G
\$5,50



WL9-BX03GO
\$5,60



WL9-BX04GO
\$5,65



WL9-BX05GO
\$5,70



WL9-BX06GO
\$5,75

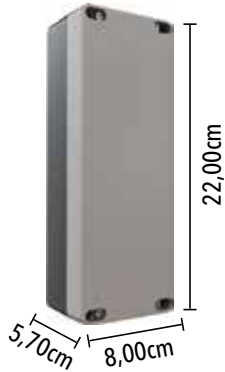

WL9-BB05G
\$6,80



WL9-BX05GB
\$6,90



WL9-BX06GB
\$6,95



WL9-BX07GB
\$7,00



WL9-BX08GB
\$7,05

WL9-BXARA3

\$2,10

WL9-BXARA2

\$1,80

WL9-BXARA1

\$1,30

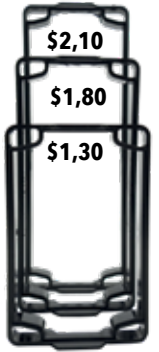

ÖNCESİ

5,70cm



7,10cm



SONRASI



WL9-BX542KAS
1NC Kontak
\$ 8,60



WL9-BX542KASE
1NC Kontak
\$9,70



WL9-BX71
1NO Kontak
\$6,50



WL9-KBZ
Kabin Altı Buzzerli İkaz Lambası
\$9,50



WL9-ELV116
1NO Kontak
\$7,00



WL9-KANT
1NO Kontak
\$8,20



WL9-ELV119
1NO/1NO Kontak
\$9,50



WL9-BYP101
Kutulu Bypass Şalteri
\$37,00



WL9-ELV310
\$19,00



WL9-ELV415
\$25,00



WL9-ELV415E
\$26,50



WL9-ELV511
\$28,50



WL9-ELV511E
\$30,00



WL9-ELV614
\$30,00



WL9-ELV616E
\$31,50



WL9-ELV510
\$31,00



WL9-ELV610
\$33,70



WL9-ELV3142
\$18,50



WL9-ELV421
\$19,00



WL9-ELV421E
\$20,00



WL9-ELV421K
\$21,00



WL9-ELV421EK
\$22,00



WL9-KKK
\$23,80



WL9-KKKS
\$26,00



WL9-KY1-50
9V Pili Alarm Seti
\$20,80



WL9-BYP301
\$45,50



WL9-BYP401
\$53,50



WL9-3BY501
\$44,50



WL9-BYP601
\$55,50



WL5-KY1-60
9V Pili Alarm Seti
\$23,50



WL9-BYP602
\$29,00



WL9-KY5-24V
\$31,50



WL9-ELV711
\$42,00



WL9-ELV811
\$46,00



WL9-ELV911
\$53,00



WL9-ELV1011
\$56,00



VK - TEK HIZLI VİNÇ KUMANDA BUTONU - MEKANİK KİLİTLİ

KOD	ÖZELLİK	PKT ADEDİ	FİYAT / ADET
WLK-2 (VK-2)	Tek Hızlı 2'li Mekanik Kilitli Kontak 5A	1	\$7,60
WLK-4 (VK-4)	Tek Hızlı 4'lü Mekanik Kilitli Kontak 5A	1	\$10,00
WLK-6 (VK-6)	Tek Hızlı 6'lı Mekanik Kilitli Kontak 5A	1	\$12,70



VKB - TEK HIZLI VİNÇ KUMANDA BUTONU MEKANİK KİLİTLİ - FAZ BAĞLANTI KÖPRÜLÜ

KOD	ÖZELLİK	PKT ADEDİ	FİYAT / ADET
WLKB-3 (VKB-3)	2 + Acil Stop Tek Hızlı Mekanik Kilitli Kontak - 16A	1	\$24,60
WLKB-5 (VKB-5)	4 + Acil Stop Tek Hızlı Mekanik Kilitli Kontak - 16A	1	\$34,20
WLKB-7 (VKB-7)	6 + Acil Stop Tek Hızlı Mekanik Kilitli Kontak - 16A	1	\$44,50
WLKB-9 (VKB-9)	8 + Acil Stop Tek Hızlı Mekanik Kilitli Kontak - 16A	1	\$53,50



VK2 - ÇİFT HIZLI VİNÇ KUMANDA BUTONU - MEKANİK KİLİTLİ

KOD	ÖZELLİK	PKT ADEDİ	FİYAT / ADET
WLK2-3 (VK-2-3)	2'li + Acil Stop Çift Hızlı Mekanik Kilitli Kontak 16A	1	\$47,50
WLK2-5 (VK-2-5)	4'lü + Acil Stop Çift Hızlı Mekanik Kilitli Kontak 16A	1	\$59,50
WLK2-7 (VK-2-7)	6'li + Acil Stop Çift Hızlı Mekanik Kilitli Kontak 16A	1	\$74,30
WLK2-9 (VK-2-9)	8'li + Acil Stop Çift Hızlı Mekanik Kilitli Kontak 16A	1	\$90,50



MONOFAZE ve TRİFAZE VİNÇ KUMANDA BUTONU

KOD	ÖZELLİK	PKT ADEDİ	FİYAT / ADET
WLKB-M3	2'li + 1 Acil Stoplu Monofaze Mekanik Kilitli Vinç Kumandası 25A	1	\$39,20
WLKB-T2	2'li Trifaze Mekanik Kilitli Vinç Kumandası 25A	1	\$47,50



VİNÇ KUMANDA BUTONU

KOD	ÖZELLİK	PKT ADEDİ	FİYAT / ADET
MN-VK2	Anahtarlı Monofaze Vinç Kumanda Kondansatör Kutulu (İçinde Kondansatör Bulunmamaktadır.)	1	\$16,00

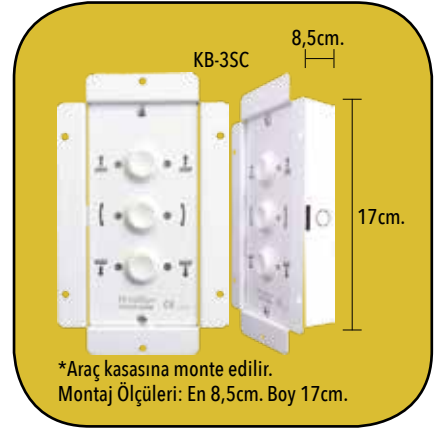

KB SERİSİ ARAÇ LİFT KUMANDA BUTONU

KOD	ÖZELLİK	PKT ADEDİ	FİYAT / ADET
KB-2	Tek Hızlı 2'li Çift Kontaklı Araç Lift Kumandası	1	\$16,50
KB-3	Tek Hızlı 3'lü Çift Kontaklı Araç Lift Kumandası	1	\$23,00
KB-4	Tek Hızlı 4'lü Çift Kontaklı Araç Lift Kumandası	1	\$27,00
KB-3A	Tek Hızlı 3'lü Acil Stoplu Çift Kontaklı Araç Lift Kumandası	1	\$25,00
KB-4A	Tek Hızlı 4'lü Acil Stoplu Çift Kontaklı Araç Lift Kumandası	1	\$29,00
KB-5A	Tek Hızlı 5'li Acil Stoplu Çift Kontaklı Araç Lift Kumandası	1	\$33,50
KB-3SC	Metal Tek Hızlı 3'lü Çift Kontaklı Lift Kumandası	1	\$40,00



KOD	ÖZELLİK	PKT ADEDİ	FİYAT / ADET
BKB-2	Tek Hızlı 2'li Ø22mm Butonlu Çift Kontaklı Araç Lift Kumandası	1	\$18,00
BKB-3	Tek Hızlı 3'lü Ø22mm Butonlu Çift Kontaklı Araç Lift Kumandası	1	\$25,00
BKB-4	Tek Hızlı 4'lü Ø22mm Butonlu Çift Kontaklı Araç Lift Kumandası	1	\$28,50
BKB-3A	Tek Hızlı 3'lü Ø22mm Butonlu Acil Stoplu Çift Kontaklı Araç Lift Kumandası	1	\$26,50
BKB-4A	Tek Hızlı 4'lü Ø22mm Butonlu Acil Stoplu Çift Kontaklı Araç Lift Kumandası	1	\$30,00
BKB-5A	Tek Hızlı 5'li Ø22mm Butonlu Acil Stoplu Çift Kontaklı Araç Lift Kumandası	1	\$35,00
KB-KK	Metal Asma Koruma Kılıfı *Araç Kasasına monte edilir.	1	\$10,00
KB-SK	5x0,75mm Spiralli Kablo (5m Uzunluğunda)	1	\$48,00

İMALATLARIMIZ



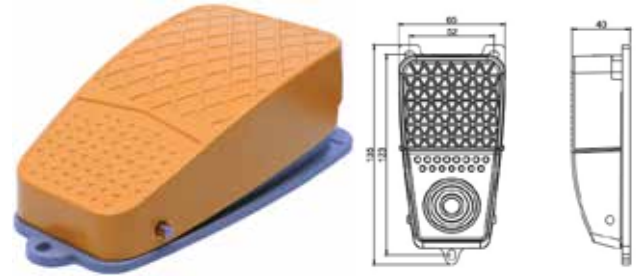

AP-1
1,5m Kablolu Metal Pedal
L:66 W:102 H:30mm
1NO/1NC
\$9,50

AP-2
1,5m Kablolu Metal Pedal
L:65 W:135 H:40mm
1NO/1NC
\$13,00

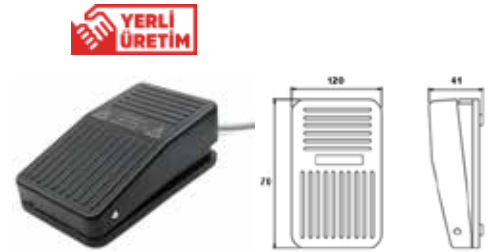
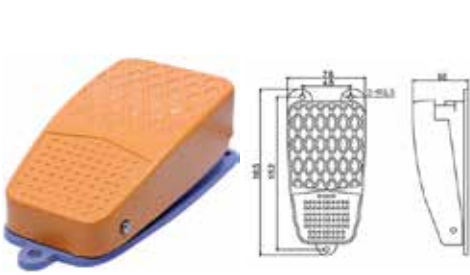

AP-3
1,5m Kablolu Metal Pedal
L:78 W:165 H:55mm
1NO/1NC
\$16,00

AP-3PY
1,5m Kablolu Plastik Pedal
L:70 W:120 H:41mm
1NO/1NC
\$14,00

AP-3PS
1,5m Kablolu Plastik Pedal
L:70 W:120 H:41mm
1NO/1NC
\$12,00

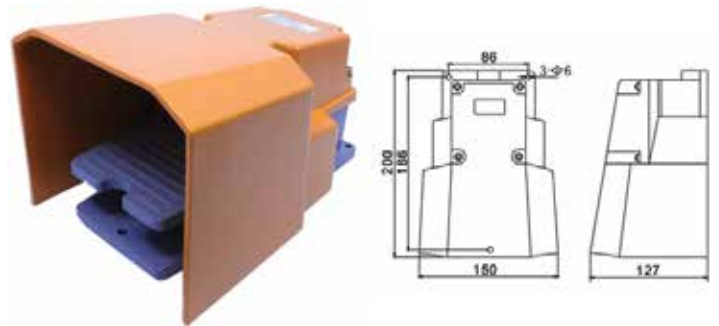
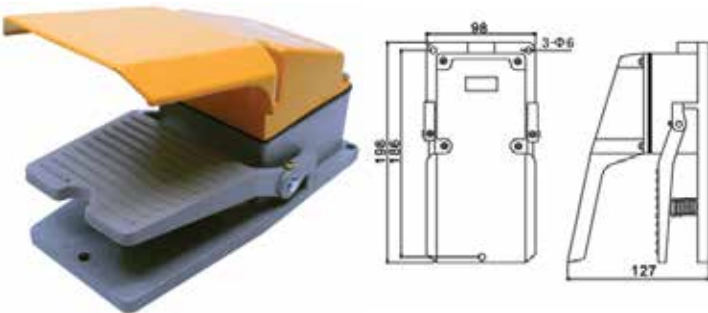

F15M
Yarım Korumalı Döküm Pedal
L:98 W:198 H:127mm
1NO/1NC
\$37,50

AP-9
Tam Korumalı Döküm Pedal
L:150 W:200 H:127mm
1NO/1NC
\$49,00

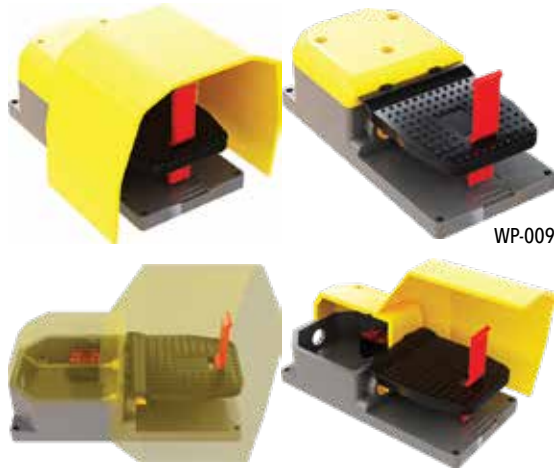

WP-009



WP-011



WP-012



TSBK

AYAK PEDALLARI (YERLİ İMALAT)

KOD	ÖZELLİK	KONTAK	PKT ADEDİ	FİYAT / ADET
WP-009	Tekli Mandal Korumalı Döküm Pedal 1k	1NO+1NC	1	\$80,80
WP-010	Tekli Tam Korumalı Döküm Pedal 1k	1NO+1NC	1	\$80,80
WP-011	Tutma Borulu Tekli Tam Korumalı Döküm Pedal 1k	1NO+1NC	1	\$98,00
WP-012	Tutma Saplı Tekli Buton Kutulu Tekli Tam Korumalı Döküm Pedal 1k	1NO+1NC	1	\$117,00
WP-013	Tekli Tam Korumalı Döküm Pedal 2k	2NO+2NC	1	\$96,50
WP-014	Tutma Borulu Tekli Tam Korumalı Döküm Pedal 2k	2NO+2NC	1	\$128,50
WP-015	Tutma Saplı Tekli Buton Kutulu Tekli Tam Korumalı Döküm Pedal 2k	2NO+2NC	1	\$132,50
WP-016	Tekli Tam Korumalı, Stoplu, Kademeli Döküm Pedal	2NO+2NC	1	\$116,50
WP-017	Tutma Borulu Tekli Tam Korumalı, Stoplu, Kademeli Döküm Pedal	2NO+2NC	1	\$134,50
WP-018	Tutma Saplı Tekli Buton Kutulu Tekli Tam Korumalı, Stoplu, Kademeli Döküm Pedal	2NO+2NC	1	\$153,00
TSBK	30x30 Profilli Tutma Saplı Tekli Buton Kutulu		1	\$36,20

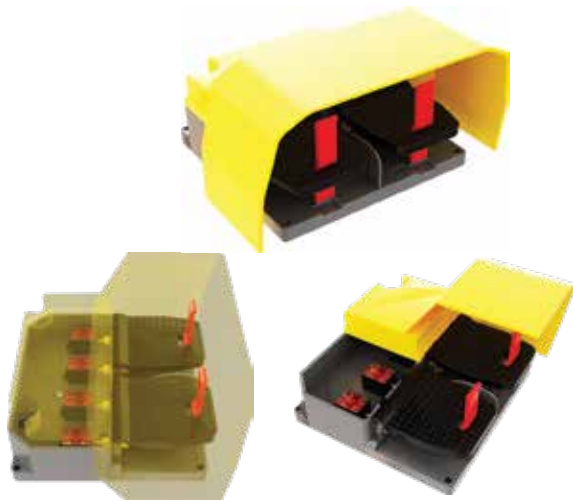

WP-021



WP-022



WP-023

AYAK PEDALLARI (YERLİ İMALAT)

KOD	ÖZELLİK	KONTAK	PKT ADEDİ	FİYAT / ADET
WP-020	Çiftli Tam Korumalı Döküm Pedal 1k+1k	1NO/1NC + 1NO/1NC	1	\$129,90
WP-021	40x40 Tutma Profilli Çiftli Tam Korumalı Döküm Pedal 1k+1k	1NO/1NC + 1NO/1NC	1	\$158,50
WP-022	Tutma Saplı Tekli Buton Kutulu Çiftli Tam Korumalı Döküm Pedal 1k+1k	1NO/1NC + 1NO/1NC	1	\$171,50
WP-023	Tutma Saplı Çiftli Buton Kutulu Çiftli Tam Korumalı Döküm Pedal 1k+1k	1NO/1NC + 1NO/1NC	1	\$173,80
WP-024	Çiftli Tam Korumalı Döküm Pedal 1k+2k	1NO/1NC + 2NO/2NC	1	\$141,60
WP-025	Çiftli Tam Korumalı Döküm Pedal 1k+2k Demir Kademeli	1NO/1NC + 2NO/2NC	1	\$171,40
WP-026	Çiftli Tam Korumalı Döküm Pedal 1k+3k Demir Kademeli	1NO/1NC + 3NO/3NC	1	\$187,20



WP-030

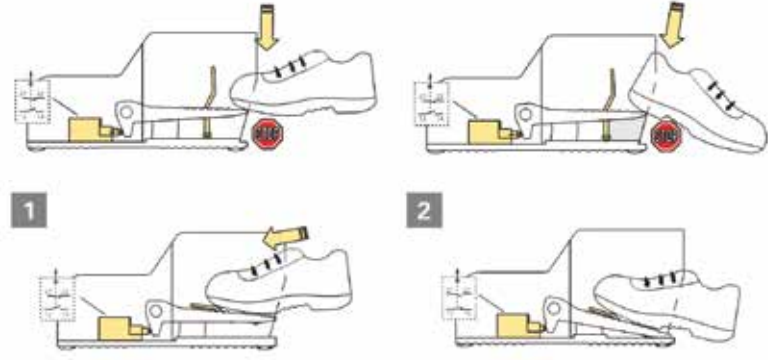

AYAK PEDALLARI (YERLİ İMALAT)

KOD	ÖZELLİK	KONTAK	PKT ADEDİ	FİYAT / ADET
WP-030	Üçlü Tam Korumalı Döküm Pedal 1k+1k+1k	1NO/1NC + 1NO/1NC + 1NO/1NC	1	\$247,00
WP-031	Üçlü Tam Korumalı Döküm Pedal 1k+1k+2k	1NO/1NC + 1NO/1NC + 2NO/2NC	1	\$272,00
WP-032	Üçlü Tam Korumalı Döküm Pedal 1k+2k+2k	1NO/1NC + 2NO/2NC + 2NO/2NC	1	\$297,00
WP-033	Üçlü Tam Korumalı Döküm Pedal 2k+2k+2k	2NO/2NC + 2NO/2NC + 2NO/2NC	1	\$320,00



WK-010



WK-021



WK-022



WP-024



WK-020



WK-PK01



WK-PK10



WK-PK20

AYAK PEDALLARI ve KONTROL PANELLERİ(YERLİ İMALAT)

KOD	ÖZELLİK	KONTAK	PKT ADEDİ	FİYAT / ADET
WK-010	Küçük Kumanda Paneli		1	\$69,00
WK-020	Çift El Kumanda Paneli Alüminyum		1	\$128,00
WK-021	Çift El Kumanda Paneli Komple		1	\$277,00
WK-022	Çift El Kumanda Paneli Tekli Tam Korumalı Döküm Pedal 1k	1NO+1NC	1	\$358,00
WK-023	Çift El Kumanda Paneli Çiftli Tam Korumalı Döküm Pedal 1k+1k	1NO/1NC + 1NO/1NC	1	\$400,00
WK-024	Çift El Kumanda Paneli Demir İskeleti		1	\$148,00
WK-PK01	Panel Kürsü		1	\$163,00
WK-PK10	Panel Kürsü Tekli Tam Korumalı Döküm Pedal 1k	1NO+1NC	1	\$245,00
WK-PK20	Panel Kürsü Çiftli Tam Korumalı Döküm Pedal 1k+1k	1NO/1NC + 1NO/1NC	1	\$287,00

XCK PLASTİK GÖVDELİ LİMİT SWITCH



XCK-SUM211	XCK-SUM211A	XCK-SUM331	XCK-SUM332R	XCK-SIM311	XCK-SIM411
1NO+1NC	1NO+1NC	1NO+1NC	1NO+1NC	1NO+1NC	1NO+1NC
\$7,50	\$7,70	\$8,00	\$8,25	\$8,10	\$8,10



XCK-SEM121	XCK-SEM121E	XCK-SEP121	XCK-SEP121E	XCK-SEM122	XCK-SEM122E	XCK-SEP122	XCK-SEP122E
DÜZ KOL	EĞRİ KOL	DÜZ KOL	EĞRİ KOL	DÜZ KOL	EĞRİ KOL	DÜZ KOL	EĞRİ KOL
1NO+1NC	1NO+1NC	1NO+1NC	1NO+1NC	1NO+1NC	1NO+1NC	1NO+1NC	1NO+1NC
\$8,10	\$8,20	\$8,10	\$8,20	\$8,30	\$8,40	\$8,30	\$8,40



XCK-SEM123	XCK-SEM123E	XCK-SEP123	XCK-SEP123E	XCK-SEL122	XCK-SEL122E	XCK-SEL123	XCK-SEL123E
DÜZ KOL	EĞRİ KOL	DÜZ KOL	EĞRİ KOL	DÜZ KOL	EĞRİ KOL	DÜZ KOL	EĞRİ KOL
1NO+1NC	1NO+1NC	1NO+1NC	1NO+1NC	1NO+1NC	1NO+1NC	1NO+1NC	1NO+1NC
\$8,50	8,60	\$8,50	\$8,60	\$9,00	\$9,10	\$9,00	\$9,10



XCK-SOP101	XCK-SOP102	XCK-SOP103	XCK-SOM101	XCK-SOM102	XCK-REM121	XCK-REP121
1NO+1NC	1NO+1NC	1NO+1NC	1NO+1NC	1NO+1NC	1NO+1NC	1NO+1NC
\$8,10	\$8,10	\$8,10	\$8,40	\$8,40	\$8,10	\$8,60



CSA LIMIT SWITCH				
KOD	ÖZELLİK	KONTAK	PKT ADEDİ	FİYAT / ADET
CSA-001	Doğrusal Pim	1NO+1NC	1	\$20,00
CSA-003	Doğrusal Makaralı Pim	1NO+1NC	1	\$20,00
CSA-012	Doğrusal Pim Kol Makara	1NO+1NC	1	\$21,50
CSA-021	Açısal Kol Makaralı	1NO+1NC	1	\$21,50
CSA-031	Açısal Ayarlı Kol Makaralı	1NO+1NC	1	\$21,50
CSA-061	Spiral Telli	1NO+1NC	1	\$21,50
CSA-071	Spiral Telli + Plastik Çubuk	1NO+1NC	1	\$21,50
CSA-081	Spiral telli	1NO+1NC	1	\$21,50
CSA-091	Açısal Ayarlı Kol 50mm Kauçuk Makara	1NO+1NC	1	\$24,00



CWL LIMIT SWITCH				
KOD	ÖZELLİK	KONTAK	PKT ADEDİ	FİYAT / ADET
CWLD	Doğrusal Pim	1NO+1NC	1	\$34,50
CWLD1	Doğrusal Makaralı Pim	1NO+1NC	1	\$35,50
CWLD2	Doğrusal Ters Makaralı Pim	1NO+1NC	1	\$35,50
CWLD3	Doğrusal Bilyeli Pim	1NO+1NC	1	\$36,50
CWLNJ	Spiral Telli	1NO+1NC	1	\$35,50
CWLCA2-2	Açısal Kol Makaralı	1NO+1NC	1	\$37,00
CWLCL	Açısal Kol Ayarlı Çubuk	1NO+1NC	1	\$37,00
CWLCA12-2Q	Açısal Kol Ayarlı Makaralı	1NO+1NC	1	\$37,00
CWLCA32-41	Çatal Kol Çift Makaralı	1NO+1NC	1	\$39,50



TZ LIMIT SWITCH				
KOD	ÖZELLİK	KONTAK	PKT ADEDİ	FİYAT / ADET
TZ-8104	Açısal Kol Plastik Makaralı	1NO+1NC	10	\$21,00
TZ-8105	Açısal Kol Metal Makaralı	1NO+1NC	10	\$21,80
TZ-8107	Açısal Kol Ayarlı Metal Çubuk	1NO+1NC	10	\$21,00
TZ-8108	Açısal Kol Ayarlı Plastik Makaralı	1NO+1NC	10	\$21,00
TZ-8109	Açısal Kol Ayarlı Metal Makaralı	1NO+1NC	10	\$21,80
TZ-8111	Doğrusal Pim	1NO+1NC	10	\$19,00
TZ-8112	Doğrusal Makaralı Pim	1NO+1NC	10	\$19,00
TZ-8166	Spiral Telli Plastik Çubuk	1NO+1NC	10	\$20,00
TZ-8167	Spiral Telli	1NO+1NC	10	\$20,00
TZ-8168	Spiral Telli Metal Çubuk	1NO+1NC	10	\$20,00
TZ-8169	Telli	1NO+1NC	10	\$20,00

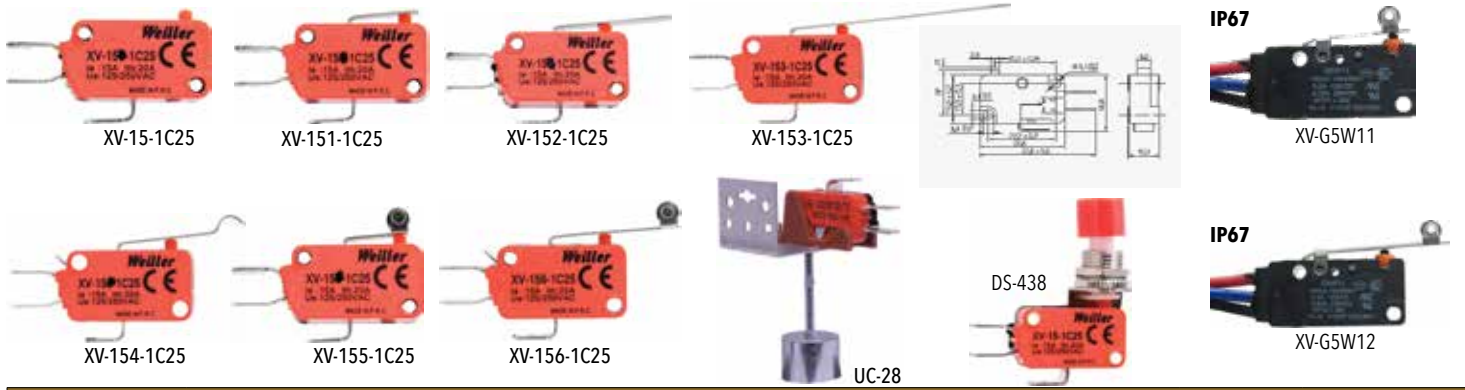

MICRO SWITCH (SILVER CONTACT)				
KOD	ÖZELLİK	KONTAK	PKT ADEDİ	FİYAT / ADET
XV-15-1C25	Buton Tip Pimli	1NO+1NC	100	\$1,70
XV-151-1C25	Kısa Palet	1NO+1NC	100	\$1,70
XV-152-1C25	Orta Palet	1NO+1NC	100	\$1,85
XV-153-1C25	Uzun Palet	1NO+1NC	100	\$1,85
XV-154-1C25	Çengel Palet	1NO+1NC	100	\$1,85
XV-155-1C25	Kısa Palet Pls. Makaralı	1NO+1NC	100	\$1,90
XV-156-1C25	Uzun Palet Pls. Makaralı	1NO+1NC	100	\$1,90
DS-438	Dikey Takrikli	1NO+1NC	100	\$5,40
UC-28	Denge Switch'i	1NO+1NC	20	\$4,50
XV-G5W11	IP67 Kısa Palet Metal Makaralı Kablolu	1NO+1NC	20	\$19,50
XV-G5W12	IP67 Uzun Palet Metal Makaralı Kablolu	1NO+1NC	20	\$19,50



MINI SWITCH (SILVER CONTACT) KIRILMAZ PLASTİK GÖVDE

KOD	ÖZELLİK	KONTAK	PKT ADEDİ	FİYAT / ADET
XZ-15GD-B (CM1306)	Kalın Kısa Pimli	1NO+1NC	20	\$6,00
XZ-15GQ-B (CM1307)	Kalın Uzun Pimli	1NO+1NC	20	\$7,20
XZ-15GQ21-B (CM1309)	Dikey Metal Makaralı Pim	1NO+1NC	20	\$8,00
XZ-15GQ22-B (CM1308)	Yatay Metal Makaralı Pim	1NO+1NC	20	\$8,00
XZ-15GW-B (CM1701)	Uzun Palet	1NO+1NC	20	\$6,00
XZ-15GW21-B (CM1702)	Kısa Palet	1NO+1NC	20	\$6,00
XZ-15GW23-B	Orta Palet	1NO+1NC	20	\$6,00
XZ-15GW2-B (CM1703)	Uzun Palet Metal Makaralı	1NO+1NC	20	\$6,30
XZ-15GW3-B	Orta Palet Metal Makaralı	1NO+1NC	20	\$6,30
XZ-15GW22-B (CM1704)	Kısa Palet Metal Makaralı	1NO+1NC	20	\$6,00
XZ-15GW2277-B (CM1743)	Kısa Metal Makara Tahrikli	1NO+1NC	20	\$8,00
XZ-15HW24-B (CM1705)	Uzun Tel Palet	1NO+1NC	20	\$8,00
XZPY	Mini Switch Koruma Kılıfı Düz Plastik		100	\$1,70
XAPY	Mini Switch Koruma Kılıfı 45° Açılı Kauçuk		50	\$1,70



TOGGLE ANAHTAR

KOD	ÖZELLİK	PIN	PKT ADEDİ	FİYAT / ADET
XT-11B	On - Off Toggle Anahtar - Kalıcı	2 Pin	20	\$4,30
XT-12B	On - Off Toggle Anahtar - Kalıcı	3 Pin	20	\$5,00
XT-13B	On - Off - On Toggle Anahtar - Kalıcı	3 Pin	20	\$5,00
XT-21B	On - Off Toggle Anahtar - Kalıcı	4 Pin	20	\$6,30
XT-23B	On - Off - On Toggle Anahtar - Kalıcı	6 Pin	20	\$7,50
XT-11BF	On - Off - On Toggle Anahtar - Tek Tarafa Yaylı	2 Pin	20	\$5,00
XT-13BF	On - Off - On Toggle Anahtar - İki Tarafa Yaylı	3 Pin	20	\$5,60
WIC-161	Ø12mm Toogle Switch Kılıfı	-	20	\$0,90
WIC-161B	Toogle Switch Emniyet Kapağı	-	20	\$2,00



22M16mm SERİSİ LEDLİ YUVARLAK SİNYAL

KOD	ÖZELLİK	RENK	PKT ADEDİ	FİYAT / ADET
22M16-170W	Ø16 mm - Ø22 mm Yuvarlak Ledli Sinyal 220VAC	White	10	\$6,60
22M16-170G	Ø16 mm - Ø22 mm Yuvarlak Ledli Sinyal 220VAC	Green	10	\$6,60
22M16-170Y	Ø16 mm - Ø22 mm Yuvarlak Ledli Sinyal 220VAC	Yellow	10	\$6,60
22M16-170R	Ø16 mm - Ø22 mm Yuvarlak Ledli Sinyal 220VAC	Red	10	\$6,60
22M16-170B	Ø16 mm - Ø22 mm Yuvarlak Ledli Sinyal 220VAC	Blue	10	\$6,60



22M16mm SERİSİ LEDLİ KARE SİNYAL

KOD	ÖZELLİK	RENK	PKT ADEDİ	FİYAT / ADET
22M16-180W	Ø16 mm - Ø22 mm Kare Ledli Sinyal 220VAC	White	10	\$6,60
22M16-180G	Ø16 mm - Ø22 mm Kare Ledli Sinyal 220VAC	Green	10	\$6,60
22M16-180Y	Ø16 mm - Ø22 mm Kare Ledli Sinyal 220VAC	Yellow	10	\$6,60
22M16-180R	Ø16 mm - Ø22 mm Kare Ledli Sinyal 220VAC	Red	10	\$6,60
22M16-180B	Ø16 mm - Ø22 mm Kare Ledli Sinyal 220VAC	Blue	10	\$6,60



22M16mm SERİSİ LEDLİ YUVARLAK YAYLI BUTON

KOD	ÖZELLİK	KONTAK	RENK	PKT ADEDİ	FİYAT / ADET
22M16-271W	Ø16 mm - Ø22 mm Yuvarlak Ledli Buton 220VAC	1NO+1NC	White	10	\$13,80
22M16-271G	Ø16 mm - Ø22 mm Yuvarlak Ledli Buton 220VAC	1NO+1NC	Green	10	\$13,80
22M16-271Y	Ø16 mm - Ø22 mm Yuvarlak Ledli Buton 220VAC	1NO+1NC	Yellow	10	\$13,80
22M16-271R	Ø16 mm - Ø22 mm Yuvarlak Ledli Buton 220VAC	1NO+1NC	Red	10	\$13,80
22M16-271B	Ø16 mm - Ø22 mm Yuvarlak Ledli Buton 220VAC	1NO+1NC	Blue	10	\$13,80



22M16mm SERİSİ LEDLİ KARE YAYLI BUTON

KOD	ÖZELLİK	KONTAK	RENK	PKT ADEDİ	FİYAT / ADET
22M16-281W	Ø16 mm - Ø22 mm Kare Ledli Buton 220VAC	1NO+1NC	White	10	\$13,80
22M16-281G	Ø16 mm - Ø22 mm Kare Ledli Buton 220VAC	1NO+1NC	Green	10	\$13,80
22M16-281Y	Ø16 mm - Ø22 mm Kare Ledli Buton 220VAC	1NO+1NC	Yellow	10	\$13,80
22M16-281R	Ø16 mm - Ø22 mm Kare Ledli Buton 220VAC	1NO+1NC	Red	10	\$13,80
22M16-281B	Ø16 mm - Ø22 mm Kare Ledli Buton 220VAC	1NO+1NC	Blue	10	\$13,80



22M16mm SERİSİ LEDLİ YUVARLAK KALICI BUTON

KOD	ÖZELLİK	KONTAK	RENK	PKT ADEDİ	FİYAT / ADET
22M16-371W	Ø16 mm - Ø22 mm Yuvarlak Ledli Buton 220VAC	1NO+1NC	White	10	\$15,00
22M16-371G	Ø16 mm - Ø22 mm Yuvarlak Ledli Buton 220VAC	1NO+1NC	Green	10	\$15,00
22M16-371Y	Ø16 mm - Ø22 mm Yuvarlak Ledli Buton 220VAC	1NO+1NC	Yellow	10	\$15,00
22M16-371R	Ø16 mm - Ø22 mm Yuvarlak Ledli Buton 220VAC	1NO+1NC	Red	10	\$15,00
22M16-371B	Ø16 mm - Ø22 mm Yuvarlak Ledli Buton 220VAC	1NO+1NC	Blue	10	\$15,00



22M16mm SERİSİ LEDLİ KARE KALICI BUTON

KOD	ÖZELLİK	KONTAK	RENK	PKT ADEDİ	FİYAT / ADET
22M16-381W	Ø16 mm - Ø22 mm Kare Ledli Buton 220VAC	1NO+1NC	White	10	\$15,00
22M16-381G	Ø16 mm - Ø22 mm Kare Ledli Buton 220VAC	1NO+1NC	Green	10	\$15,00
22M16-381Y	Ø16 mm - Ø22 mm Kare Ledli Buton 220VAC	1NO+1NC	Yellow	10	\$15,00
22M16-381R	Ø16 mm - Ø22 mm Kare Ledli Buton 220VAC	1NO+1NC	Red	10	\$15,00
22M16-381B	Ø16 mm - Ø22 mm Kare Ledli Buton 220VAC	1NO+1NC	Blue	10	\$15,00

22M16mm SERİSİ LEDLİ YUVARLAK SİNYAL

KOD	ÖZELLİK	RENK	PKT ADEDİ	FİYAT / ADET
22M16-17W	Ø16 mm - Ø22 mm Yuvarlak Ledli Sinyal 24VAC/DC	⊘	10	6,00
22M16-17G	Ø16 mm - Ø22 mm Yuvarlak Ledli Sinyal 24VAC/DC	●	10	6,00
22M16-17Y	Ø16 mm - Ø22 mm Yuvarlak Ledli Sinyal 24VAC/DC	●	10	6,00
22M16-17R	Ø16 mm - Ø22 mm Yuvarlak Ledli Sinyal 24VAC/DC	●	10	6,00
22M16-17B	Ø16 mm - Ø22 mm Yuvarlak Ledli Sinyal 24VAC/DC	●	10	6,00



22M16mm SERİSİ LEDLİ KARE SİNYAL

KOD	ÖZELLİK	RENK	PKT ADEDİ	FİYAT / ADET
22M16-18W	Ø16 mm - Ø22 mm Kare Ledli Sinyal 24VAC/DC	⊘	10	\$6,60
22M16-18G	Ø16 mm - Ø22 mm Kare Ledli Sinyal 24VAC/DC	●	10	\$6,60
22M16-18Y	Ø16 mm - Ø22 mm Kare Ledli Sinyal 24VAC/DC	●	10	\$6,60
22M16-18R	Ø16 mm - Ø22 mm Kare Ledli Sinyal 24VAC/DC	●	10	\$6,60
22M16-18B	Ø16 mm - Ø22 mm Kare Ledli Sinyal 24VAC/DC	●	10	\$6,60



22M16mm SERİSİ LEDLİ YUVARLAK YAYLI BUTON

KOD	ÖZELLİK	KONTAK	RENK	PKT ADEDİ	FİYAT / ADET
22M16-27W	Ø16 mm - Ø22 mm Yuvarlak Ledli Buton 24VAC/DC	1NO+1NC	⊘	10	\$13,80
22M16-27G	Ø16 mm - Ø22 mm Yuvarlak Ledli Buton 24VAC/DC	1NO+1NC	●	10	\$13,80
22M16-27Y	Ø16 mm - Ø22 mm Yuvarlak Ledli Buton 24VAC/DC	1NO+1NC	●	10	\$13,80
22M16-27R	Ø16 mm - Ø22 mm Yuvarlak Ledli Buton 24VAC/DC	1NO+1NC	●	10	\$13,80
22M16-27B	Ø16 mm - Ø22 mm Yuvarlak Ledli Buton 24VAC/DC	1NO+1NC	●	10	\$13,80



22M16mm SERİSİ LEDLİ KARE YAYLI BUTON

KOD	ÖZELLİK	KONTAK	RENK	PKT ADEDİ	FİYAT / ADET
22M16-28W	Ø16 mm - Ø22 mm Kare Ledli Buton 24VAC/DC	1NO+1NC	⊘	10	\$13,80
22M16-28G	Ø16 mm - Ø22 mm Kare Ledli Buton 24VAC/DC	1NO+1NC	●	10	\$13,80
22M16-28Y	Ø16 mm - Ø22 mm Kare Ledli Buton 24VAC/DC	1NO+1NC	●	10	\$13,80
22M16-28R	Ø16 mm - Ø22 mm Kare Ledli Buton 24VAC/DC	1NO+1NC	●	10	\$13,80
22M16-28B	Ø16 mm - Ø22 mm Kare Ledli Buton 24VAC/DC	1NO+1NC	●	10	\$13,80



22M16mm SERİSİ LEDLİ YUVARLAK KALICI BUTON

KOD	ÖZELLİK	KONTAK	RENK	PKT ADEDİ	FİYAT / ADET
22M16-37W	Ø16 mm - Ø22 mm Yuvarlak Ledli Buton 24VAC/DC	1NO+1NC	⊘	10	\$15,00
22M16-37G	Ø16 mm - Ø22 mm Yuvarlak Ledli Buton 24VAC/DC	1NO+1NC	●	10	\$15,00
22M16-37Y	Ø16 mm - Ø22 mm Yuvarlak Ledli Buton 24VAC/DC	1NO+1NC	●	10	\$15,00
22M16-37R	Ø16 mm - Ø22 mm Yuvarlak Ledli Buton 24VAC/DC	1NO+1NC	●	10	\$15,00
22M16-37B	Ø16 mm - Ø22 mm Yuvarlak Ledli Buton 24VAC/DC	1NO+1NC	●	10	\$15,00



22M16mm SERİSİ LEDLİ KARE KALICI BUTON

KOD	ÖZELLİK	KONTAK	RENK	PKT ADEDİ	FİYAT / ADET
22M16-38W	Ø16 mm - Ø22 mm Kare Ledli Buton 24VAC/DC	1NO+1NC	⊘	10	\$15,00
22M16-38G	Ø16 mm - Ø22 mm Kare Ledli Buton 24VAC/DC	1NO+1NC	●	10	\$15,00
22M16-38Y	Ø16 mm - Ø22 mm Kare Ledli Buton 24VAC/DC	1NO+1NC	●	10	\$15,00
22M16-38R	Ø16 mm - Ø22 mm Kare Ledli Buton 24VAC/DC	1NO+1NC	●	10	\$15,00
22M16-38B	Ø16 mm - Ø22 mm Kare Ledli Buton 24VAC/DC	1NO+1NC	●	10	\$15,00





22M16mm SERİSİ KISA TİP YAYLI YUVARLAK LEDLİ BUTONLAR

KOD	ÖZELLİK	VOLTAJ	KONTAK	RENK	PKT ADEDİ	FİYAT / ADET
22M16-47W	Ø16 - Ø22 mm Kısa Tip Yuvarlak Ledli Buton	24V.DC	1NO+1NC	☐	10	\$12,50
22M16-47G	Ø16 - Ø22 mm Kısa Tip Yuvarlak Ledli Buton	24V.DC	1NO+1NC	●	10	\$12,50
22M16-47Y	Ø16 - Ø22 mm Kısa Tip Yuvarlak Ledli Buton	24V.DC	1NO+1NC	●	10	\$12,50
22M16-47R	Ø16 - Ø22 mm Kısa Tip Yuvarlak Ledli Buton	24V.DC	1NO+1NC	●	10	\$12,50
22M16-47B	Ø16 - Ø22 mm Kısa Tip Yuvarlak Ledli Buton	24V.DC	1NO+1NC	●	10	\$12,50

22M16mm SERİSİ KISA TİP KALICI YUVARLAK LEDLİ BUTONLAR

KOD	ÖZELLİK	VOLTAJ	KONTAK	RENK	PKT ADEDİ	FİYAT / ADET
22M16-57W	Ø16 - Ø22 mm Kısa Tip Kalıcı Yuvarlak Ledli Buton	24V.DC	1NO+1NC	☐	10	\$13,80
22M16-57G	Ø16 - Ø22 mm Kısa Tip Kalıcı Yuvarlak Ledli Buton	24V.DC	1NO+1NC	●	10	\$13,80
22M16-57Y	Ø16 - Ø22 mm Kısa Tip Kalıcı Yuvarlak Ledli Buton	24V.DC	1NO+1NC	●	10	\$13,80
22M16-57R	Ø16 - Ø22 mm Kısa Tip Kalıcı Yuvarlak Ledli Buton	24V.DC	1NO+1NC	●	10	\$13,80
22M16-57B	Ø16 - Ø22 mm Kısa Tip Kalıcı Yuvarlak Ledli Buton	24V.DC	1NO+1NC	●	10	\$13,80

16mm YUVARLAK YAYLI PLASTİK LEDLİ BUTONLAR

KOD	ÖZELLİK	VOLTAJ	KONTAK	RENK	PKT ADEDİ	FİYAT / ADET
WLY-11-24W	16mm Yaylı Yuvarlak Buton - 5 Pin	24V.DC	1NO+1NC	☐	10	\$8,00
WLY-11-24G	16mm Yaylı Yuvarlak Buton - 5 Pin	24V.DC	1NO+1NC	●	10	\$8,00
WLY-11-24R	16mm Yaylı Yuvarlak Buton - 5 Pin	24V.DC	1NO+1NC	●	10	\$8,00
WLY-11-24Y	16mm Yaylı Yuvarlak Buton - 5 Pin	24V.DC	1NO+1NC	●	10	\$8,00
WLY-11-24B	16mm Yaylı Yuvarlak Buton - 5 Pin	24V.DC	1NO+1NC	●	10	\$8,00



16mm KARE YAYLI PLASTİK LEDLİ BUTONLAR

KOD	ÖZELLİK	VOLTAJ	KONTAK	RENK	PKT ADEDİ	FİYAT / ADET
WLK-11-24W	16mm Yaylı Kare Buton - 5 Pin	24V.DC	1NO+1NC	☐	10	\$8,00
WLK-11-24G	16mm Yaylı Kare Buton - 5 Pin	24V.DC	1NO+1NC	●	10	\$8,00
WLK-11-24R	16mm Yaylı Kare Buton - 5 Pin	24V.DC	1NO+1NC	●	10	\$8,00
WLK-11-24Y	16mm Yaylı Kare Buton - 5 Pin	24V.DC	1NO+1NC	●	10	\$8,00
WLK-11-24B	16mm Yaylı Kare Buton - 5 Pin	24V.DC	1NO+1NC	●	10	\$8,00



16mm DİKDÖRTGEN YAYLI PLASTİK LEDLİ BUTONLAR

KOD	ÖZELLİK	VOLTAJ	KONTAK	RENK	PKT ADEDİ	FİYAT / ADET
WLD-11-24W	16mm Yaylı Dikdörtgen Buton - 5 Pin	24V.DC	1NO+1NC	☐	10	\$8,00
WLD-11-24G	16mm Yaylı Dikdörtgen Buton - 5 Pin	24V.DC	1NO+1NC	●	10	\$8,00
WLD-11-24R	16mm Yaylı Dikdörtgen Buton - 5 Pin	24V.DC	1NO+1NC	●	10	\$8,00
WLD-11-24Y	16mm Yaylı Dikdörtgen Buton - 5 Pin	24V.DC	1NO+1NC	●	10	\$8,00
WLD-11-24B	16mm Yaylı Dikdörtgen Buton - 5 Pin	24V.DC	1NO+1NC	●	10	\$8,00



16mm YUVARLAK KALICILI PLASTİK LEDLİ BUTONLAR

KOD	ÖZELLİK	VOLTAJ	KONTAK	RENK	PKT ADEDİ	FİYAT / ADET
WLY-11K-24W	16mm Kalıcı Yuvarlak Buton - 5 Pin	24V.DC	1NO+1NC	☐	10	\$9,50
WLY-11K-24G	16mm Kalıcı Yuvarlak Buton - 5 Pin	24V.DC	1NO+1NC	●	10	\$9,50
WLY-11K-24R	16mm Kalıcı Yuvarlak Buton - 5 Pin	24V.DC	1NO+1NC	●	10	\$9,50
WLY-11K-24Y	16mm Kalıcı Yuvarlak Buton - 5 Pin	24V.DC	1NO+1NC	●	10	\$9,50
WLY-11K-24B	16mm Kalıcı Yuvarlak Buton - 5 Pin	24V.DC	1NO+1NC	●	10	\$9,50



16mm KARE KALICILI PLASTİK LEDLİ BUTONLAR

KOD	ÖZELLİK	VOLTAJ	KONTAK	RENK	PKT ADEDİ	FİYAT / ADET
WLK-11K-24W	16mm Kalıcı Kare Buton - 5 Pin	24V.DC	1NO+1NC	⊖	10	\$9,50
WLK-11K-24G	16mm Kalıcı Kare Buton - 5 Pin	24V.DC	1NO+1NC	⊕	10	\$9,50
WLK-11K-24R	16mm Kalıcı Kare Buton - 5 Pin	24V.DC	1NO+1NC	⊕	10	\$9,50
WLK-11K-24Y	16mm Kalıcı Kare Buton - 5 Pin	24V.DC	1NO+1NC	⊖	10	\$9,50
WLK-11K-24B	16mm Kalıcı Kare Buton - 5 Pin	24V.DC	1NO+1NC	⊕	10	\$9,50



16mm DİKDÖRTGEN KALICILI PLASTİK LEDLİ BUTONLAR

KOD	ÖZELLİK	VOLTAJ	KONTAK	RENK	PKT ADEDİ	FİYAT / ADET
WLD-11K-24W	16mm Kalıcı Dikdörtgen Buton - 5 Pin	24V.DC	1NO+1NC	⊖	10	\$9,50
WLD-11K-24G	16mm Kalıcı Dikdörtgen Buton - 5 Pin	24V.DC	1NO+1NC	⊕	10	\$9,50
WLD-11K-24R	16mm Kalıcı Dikdörtgen Buton - 5 Pin	24V.DC	1NO+1NC	⊕	10	\$9,50
WLD-11K-24Y	16mm Kalıcı Dikdörtgen Buton - 5 Pin	24V.DC	1NO+1NC	⊖	10	\$9,50
WLD-11K-24B	16mm Kalıcı Dikdörtgen Buton - 5 Pin	24V.DC	1NO+1NC	⊕	10	\$9,50



16mm PLASTİK ACİL STOP BUTONLARI

KOD	ÖZELLİK	KONTAK	PKT ADEDİ	FİYAT / ADET
WLY-11TS	16mm Acil Stop Butonu (BAS-ÇEVİR)	1NO+1NC	10	\$13,50
WLY-22TS	16mm Acil Stop Butonu (BAS-ÇEVİR)	2NO+2NC	10	\$15,50



16mm PLASTİK ACİL STOP BUTONLARI

KOD	ÖZELLİK	KONTAK	PKT ADEDİ	FİYAT / ADET
WL-180-D27	16mm Acil Stop Butonu (BAS-ÇEVİR)	2NC	10	\$13,50
WL-180-D33	16mm Acil Stop Butonu (BAS-ÇEVİR)	2NC	10	\$15,50



16mm PLASTİK MANDAL BUTONLAR

KOD	ÖZELLİK	KONTAK	PKT ADEDİ	FİYAT / ADET
WL-11X-21	16mm 0-1 Yuvarlak Kalıcı Mandal Buton	1NO+1NC	10	\$12,50
WL-22X-21	16mm 0-1 Yuvarlak Kalıcı Mandal Buton	2NO+2NC	10	\$14,50
WL-22X-31	16mm 1-0-2 Yuvarlak Kalıcı Mandal Buton	2NO+2NC	10	\$14,50



16mm PLASTİK ANAHTARLI BUTON

KOD	ÖZELLİK	KONTAK	PKT ADEDİ	FİYAT / ADET
WL-22A-21	16mm 0-1 Yuvarlak Anahtarlı Kalıcı Buton	2NO+2NC	10	\$13,50



16mm PLASTİK ACİL STOP BUTONLARI

KOD	ÖZELLİK	KONTAK	PKT ADEDİ	FİYAT / ADET
F16-A11R	16mm Acil Stop Butonu (BAS-ÇEVİR) ETİKETLİ	1NO+1NC	8	\$23,00
F16-811R	16mm Acil Stop Butonu (BAS-ÇEVİR)	1NO+1NC	8	\$22,00





16mm PLASTİK YAYLI YUVARLAK HALKA LEDLİ BUTONLAR / IP67

KOD	ÖZELLİK	VOLTAJ	KONTAK	RENK	PKT ADEDİ	FİYAT / ADET
WLY-16-24W	16mm Yaylı Yuvarlak Halka Ledli Buton	24V.DC	1NO+1NC	White	10	\$14,50
WLY-16-24G	16mm Yaylı Yuvarlak Halka Ledli Buton	24V.DC	1NO+1NC	Green	10	\$14,50
WLY-16-24R	16mm Yaylı Yuvarlak Halka Ledli Buton	24V.DC	1NO+1NC	Red	10	\$14,50
WLY-16-24Y	16mm Yaylı Yuvarlak Halka Ledli Buton	24V.DC	1NO+1NC	Yellow	10	\$14,50
WLY-16-24B	16mm Yaylı Yuvarlak Halka Ledli Buton	24V.DC	1NO+1NC	Blue	10	\$14,50



16mm PLASTİK KALICI YUVARLAK HALKA LEDLİ BUTONLAR / IP67

KOD	ÖZELLİK	VOLTAJ	KONTAK	RENK	PKT ADEDİ	FİYAT / ADET
WLY-16K-24W	16mm Kalıclı Yuvarlak Halka Ledli Buton	24V.DC	1NO+1NC	White	10	\$15,00
WLY-16K-24G	16mm Kalıclı Yuvarlak Halka Ledli Buton	24V.DC	1NO+1NC	Green	10	\$15,00
WLY-16K-24R	16mm Kalıclı Yuvarlak Halka Ledli Buton	24V.DC	1NO+1NC	Red	10	\$15,00
WLY-16K-24Y	16mm Kalıclı Yuvarlak Halka Ledli Buton	24V.DC	1NO+1NC	Yellow	10	\$15,00
WLY-16K-24B	16mm Kalıclı Yuvarlak Halka Ledli Buton	24V.DC	1NO+1NC	Blue	10	\$15,00



19mm PLASTİK YAYLI YUVARLAK HALKA LEDLİ BUTONLAR / IP67

KOD	ÖZELLİK	VOLTAJ	KONTAK	RENK	PKT ADEDİ	FİYAT / ADET
WLY-19-24W	19mm Kalıclı Yuvarlak Halka Ledli Buton	24V.DC	1NO+1NC	White	10	\$17,50
WLY-19-24G	19mm Kalıclı Yuvarlak Halka Ledli Buton	24V.DC	1NO+1NC	Green	10	\$17,50
WLY-19-24R	19mm Kalıclı Yuvarlak Halka Ledli Buton	24V.DC	1NO+1NC	Red	10	\$17,50
WLY-19-24Y	19mm Kalıclı Yuvarlak Halka Ledli Buton	24V.DC	1NO+1NC	Yellow	10	\$17,50
WLY-19-24B	19mm Kalıclı Yuvarlak Halka Ledli Buton	24V.DC	1NO+1NC	Blue	10	\$17,50



19mm PLASTİK KALICI YUVARLAK HALKA LEDLİ BUTONLAR / IP67

KOD	ÖZELLİK	VOLTAJ	KONTAK	RENK	PKT ADEDİ	FİYAT / ADET
WLY-19K-24W	19mm Kalıclı Yuvarlak Halka Ledli Buton	24V.DC	1NO+1NC	White	10	\$18,50
WLY-19K-24G	19mm Kalıclı Yuvarlak Halka Ledli Buton	24V.DC	1NO+1NC	Green	10	\$18,50
WLY-19K-24R	19mm Kalıclı Yuvarlak Halka Ledli Buton	24V.DC	1NO+1NC	Red	10	\$18,50
WLY-19K-24Y	19mm Kalıclı Yuvarlak Halka Ledli Buton	24V.DC	1NO+1NC	Yellow	10	\$18,50
WLY-19K-24B	19mm Kalıclı Yuvarlak Halka Ledli Buton	24V.DC	1NO+1NC	Blue	10	\$18,50

EJ16 SERİSİ METAL LEDLİ ve LEDSİZ YAYLI BUTONLAR - IP67 (24V DC)

KOD	ÖZELLİK	RENK	PKT ADEDİ	FİYAT / ADET
EJ16-211A	16mm Yaylı Yuvarlak Ledsiz Düz Kafa Buton 2 Vidalı	-	10	\$9,50
EJ16-221A	16mm Yaylı Yuvarlak Ledsiz Çukuk Kafa Buton 2 Vidalı	-	10	\$9,50
EJ16-231A	16mm Yaylı Yuvarlak Ledsiz Bombe Kafa Buton 2 Vidalı	-	10	\$9,50
EJ16-271P-WD	16mm Yaylı Yuvarlak Halka Ledli Buton 4 Pin	●	10	\$12,00
EJ16-271P-GD	16mm Yaylı Yuvarlak Halka Ledli Buton 4 Pin	●	10	\$12,00
EJ16-271P-RD	16mm Yaylı Yuvarlak Halka Ledli Buton 4 Pin	●	10	\$12,00
EJ16-271P-YD	16mm Yaylı Yuvarlak Halka Ledli Buton 4 Pin	●	10	\$12,00
EJ16-271P-BD	16mm Yaylı Yuvarlak Halka Ledli Buton 4 Pin	●	10	\$12,00



EJ19 SERİSİ METAL LEDLİ ve LEDSİZ YAYLI BUTONLAR - IP67 (24V DC)

KOD	ÖZELLİK	RENK	PKT ADEDİ	FİYAT / ADET
EJ19-211A	19mm Yaylı Yuvarlak Ledsiz Düz Kafa Buton 2 Vidalı	-	10	\$11,00
EJ19-221A	19mm Yaylı Yuvarlak Ledsiz Çukuk Kafa Buton 2 Vidalı	-	10	\$11,00
EJ19-231A	19mm Yaylı Yuvarlak Ledsiz Bombe Kafa Buton 2 Vidalı	-	10	\$11,00
EJ19-2A1A-WD	19mm Yaylı Yuvarlak Halka Ledli Buton 4 Pin	●	10	\$14,00
EJ19-2A1A-GD	19mm Yaylı Yuvarlak Halka Ledli Buton 4 Pin	●	10	\$14,00
EJ19-2A1A-RD	19mm Yaylı Yuvarlak Halka Ledli Buton 4 Pin	●	10	\$14,00
EJ19-2A1A-YD	19mm Yaylı Yuvarlak Halka Ledli Buton 4 Pin	●	10	\$14,00
EJ19-2A1A-BD	19mm Yaylı Yuvarlak Halka Ledli Buton 4 Pin	●	10	\$14,00



J16 SERİSİ METAL LEDLİ ve LEDSİZ YAYLI BUTONLAR - IP67 (6-24V DC)

KOD	ÖZELLİK	RENK	PKT ADEDİ	FİYAT / ADET
J16-211E	16mm Yaylı Yuvarlak Ledsiz Düz Kafa Buton 2 Pinli	-	10	\$12,50
J16-271-E-WD	16mm Yaylı Yuvarlak Halka Ledli Buton 5 Pin	●	10	\$14,00
J16-271-E-GD	16mm Yaylı Yuvarlak Halka Ledli Buton 5 Pin	●	10	\$14,00
J16-271-E-RD	16mm Yaylı Yuvarlak Halka Ledli Buton 5 Pin	●	10	\$14,00
J16-271-E-YD	16mm Yaylı Yuvarlak Halka Ledli Buton 5 Pin	●	10	\$14,00
J16-271-E-BD	16mm Yaylı Yuvarlak Halka Ledli Buton 5 Pin	●	10	\$14,00



J16 SERİSİ METAL LEDLİ ve LEDSİZ KALICI BUTONLAR - IP67 (6-24V DC)

KOD	ÖZELLİK	RENK	PKT ADEDİ	FİYAT / ADET
J16-311E	16mm Kalıcı Yuvarlak Ledsiz Düz Kafa Buton 2 Pinli	-	10	\$14,00
J16-371-E-WD	16mm Kalıcı Yuvarlak Halka Ledli Buton 5 Pin	●	10	\$16,00
J16-371-E-GD	16mm Kalıcı Yuvarlak Halka Ledli Buton 5 Pin	●	10	\$16,00
J16-371-E-RD	16mm Kalıcı Yuvarlak Halka Ledli Buton 5 Pin	●	10	\$16,00
J16-371-E-YD	16mm Kalıcı Yuvarlak Halka Ledli Buton 5 Pin	●	10	\$16,00
J16-371-E-BD	16mm Kalıcı Yuvarlak Halka Ledli Buton 5 Pin	●	10	\$16,00





J19 SERİSİ METAL LEDLİ ve LEDSİZ YAYLI BUTONLAR - IP67 (6-24V DC)

KOD	ÖZELLİK	RENK	PKT ADEDİ	FİYAT / ADET
J19-211	19mm Yaylı Yuvarlak Ledsiz Düz Kafa Buton 2 Pinli	-	10	\$17,50
J19-271-WD	19mm Yaylı Yuvarlak Halka Ledli Buton 5 Pin	White	10	\$19,50
J19-271-GD	19mm Yaylı Yuvarlak Halka Ledli Buton 5 Pin	Green	10	\$19,50
J19-271-RD	19mm Yaylı Yuvarlak Halka Ledli Buton 5 Pin	Red	10	\$19,50
J19-271-YD	19mm Yaylı Yuvarlak Halka Ledli Buton 5 Pin	Yellow	10	\$19,50
J19-271-BD	19mm Yaylı Yuvarlak Halka Ledli Buton 5 Pin	Blue	10	\$19,50

J19 SERİSİ METAL LEDLİ ve LEDSİZ KALICI BUTONLAR - IP67 (6-24V DC)

KOD	ÖZELLİK	RENK	PKT ADEDİ	FİYAT / ADET
J19-311	19mm Kalıcı Yuvarlak Ledsiz Düz Kafa Buton 2 Pinli	-	10	\$19,50
J19-371-WD	19mm Kalıcı Yuvarlak Halka Ledli Buton 5 Pin	White	10	\$21,00
J19-371-GD	19mm Kalıcı Yuvarlak Halka Ledli Buton 5 Pin	Green	10	\$21,00
J19-371-RD	19mm Kalıcı Yuvarlak Halka Ledli Buton 5 Pin	Red	10	\$21,00
J19-371-YD	19mm Kalıcı Yuvarlak Halka Ledli Buton 5 Pin	Yellow	10	\$21,00
J19-371-BD	19mm Kalıcı Yuvarlak Halka Ledli Buton 5 Pin	Blue	10	\$21,00

J22 SERİSİ METAL LEDLİ ve LEDSİZ YAYLI BUTONLAR - IP67 (6-24V DC)

KOD	ÖZELLİK	RENK	PKT ADEDİ	FİYAT / ADET
J22-211	22mm Yaylı Yuvarlak Ledsiz Düz Kafa Buton 2 Pinli	-	10	\$23,00
J22-271-WD	22mm Yaylı Yuvarlak Halka Ledli Buton 5 Pin	White	10	\$25,00
J22-271-GD	22mm Yaylı Yuvarlak Halka Ledli Buton 5 Pin	Green	10	\$25,00
J22-271-RD	22mm Yaylı Yuvarlak Halka Ledli Buton 5 Pin	Red	10	\$25,00
J22-271-YD	22mm Yaylı Yuvarlak Halka Ledli Buton 5 Pin	Yellow	10	\$25,00
J22-271-BD	22mm Yaylı Yuvarlak Halka Ledli Buton 5 Pin	Blue	10	\$25,00

J22 SERİSİ METAL LEDLİ ve LEDSİZ KALICI BUTONLAR - IP67 (6-24V DC)

KOD	ÖZELLİK	RENK	PKT ADEDİ	FİYAT / ADET
J22-311	22mm Kalıcı Yuvarlak Ledsiz Düz Kafa Buton 2 Pinli	-	10	\$24,50
J22-371-WD	22mm Kalıcı Yuvarlak Halka Ledli Buton 5 Pin	White	10	\$27,00
J22-371-GD	22mm Kalıcı Yuvarlak Halka Ledli Buton 5 Pin	Green	10	\$27,00
J22-371-RD	22mm Kalıcı Yuvarlak Halka Ledli Buton 5 Pin	Red	10	\$27,00
J22-371-YD	22mm Kalıcı Yuvarlak Halka Ledli Buton 5 Pin	Yellow	10	\$27,00
J22-371-BD	22mm Kalıcı Yuvarlak Halka Ledli Buton 5 Pin	Blue	10	\$27,00

19mm METAL ACİL STOP BUTONU / IP65

KOD	ÖZELLİK	KONTAK	PKT ADEDİ	FİYAT / ADET
WL19-AS542	19mm Acil Stop Butonu (BAS-ÇEVİR)	1NO+1NC	10	\$34,00

19mm METAL LEDLİ BUZZER

KOD	ÖZELLİK	PKT ADEDİ	FİYAT / ADET
	19mm Ledli Buzzer 80dB	10	\$32,00

19mm METAL LEDLİ BUZZER

KOD	ÖZELLİK	KONTAK	PKT ADEDİ	FİYAT / ADET
WL19-AG21	19mm 0-1 Metal Anahtarlı Kalıcı Buton	1NO+1NC	10	\$31,00

J16-C 16mm. Metal Yaylı Butonlar IP67 6-24V DC 20A 1NO

KOD	ÖZELLİK	RENK	PKT ADEDİ	FİYAT / ADET
J16-C-271-GD	Ledli Metal Yaylı Buton 6-24V DC - HALKA		10	\$17,60
J16-C-271-RD	Ledli Metal Yaylı Buton 6-24V DC - HALKA		10	\$17,60
J16-C-271-YD	Ledli Metal Yaylı Buton 6-24V DC - HALKA		10	\$17,60
J16-C-271-BD	Ledli Metal Yaylı Buton 6-24V DC - HALKA		10	\$17,60
J16-C-271-WD	Ledli Metal Yaylı Buton 6-24V DC - HALKA		10	\$17,60
J16-C-271-RGBD	Ledli Metal Yaylı Buton 6-24V DC - HALKA - RGB		10	\$23,00
J16-C-211	Metal Yaylı Buton - IŞIKSIZ		10	\$16,50



J16-C 16mm. Metal Kalıcı Butonlar IP67 6-24V DC 20A - 1NO

KOD	ÖZELLİK	RENK	PKT ADEDİ	FİYAT / ADET
J16-C-371-GD	Ledli Metal Kalıcı Buton 6-24V DC - Halka		10	\$19,30
J16-C-371-RD	Ledli Metal Kalıcı Buton 6-24V DC - Halka		10	\$19,30
J16-C-371-YD	Ledli Metal Kalıcı Buton 6-24V DC - Halka		10	\$19,30
J16-C-371-BD	Ledli Metal Kalıcı Buton 6-24V DC - Halka		10	\$19,30
J16-C-371-WD	Ledli Metal Kalıcı Buton 6-24V DC - Halka		10	\$19,30
J16-C-371-RGBD	Ledli Metal Kalıcı Buton 6-24V DC - Halka - RGB		10	\$24,80
J16-C-311	Metal Kalıcı Buton - Işıksız		10	\$18,20



J19-C 19mm. Metal Yaylı Butonlar IP67 6-24V DC 20A - 1NO

KOD	ÖZELLİK	RENK	PKT ADEDİ	FİYAT / ADET
J19-C-271-GD	Ledli Metal Yaylı Buton 6-24V DC - Halka		10	\$22,50
J19-C-271-RD	Ledli Metal Yaylı Buton 6-24V DC - Halka		10	\$22,50
J19-C-271-YD	Ledli Metal Yaylı Buton 6-24V DC - Halka		10	\$22,50
J19-C-271-BD	Ledli Metal Yaylı Buton 6-24V DC - Halka		10	\$22,50
J19-C-271-WD	Ledli Metal Yaylı Buton 6-24V DC - Halka		10	\$22,50
J19-C-271-RGBD	Ledli Metal Yaylı Buton 6-24V DC - Halka - RGB		10	\$27,50
J19-C-211	Metal Yaylı Buton - Işıksız		10	\$19,30



J19-C 19mm. Metal Kalıcı Butonlar IP67 6-24V DC 20A - 1NO

KOD	ÖZELLİK	RENK	PKT ADEDİ	FİYAT / ADET
J19-C-371-GD	Ledli Metal Kalıcı Buton 6-24V DC - Halka		10	\$24,80
J19-C-371-RD	Ledli Metal Kalıcı Buton 6-24V DC - Halka		10	\$24,80
J19-C-371-YD	Ledli Metal Kalıcı Buton 6-24V DC - Halka		10	\$24,80
J19-C-371-BD	Ledli Metal Kalıcı Buton 6-24V DC - Halka		10	\$24,80
J19-C-371-WD	Ledli Metal Kalıcı Buton 6-24V DC - Halka		10	\$24,80
J19-C-371-RGBD	Ledli Metal Kalıcı Buton 6-24V DC - Halka - RGB		10	\$29,70
J19-C-311	Metal Kalıcı Buton - Işıksız		10	\$21,50



J22-C 22mm. Metal Yaylı Butonlar IP67 6-24V DC 20A - 1NO

KOD	ÖZELLİK	RENK	PKT ADEDİ	FİYAT / ADET
J22-C-271-GD	Ledli Metal Yaylı Buton 6-24V DC - Halka		10	\$27,00
J22-C-271-RD	Ledli Metal Yaylı Buton 6-24V DC - Halka		10	\$27,00
J22-C-271-YD	Ledli Metal Yaylı Buton 6-24V DC - Halka		10	\$27,00
J22-C-271-BD	Ledli Metal Yaylı Buton 6-24V DC - Halka		10	\$27,00
J22-C-271-WD	Ledli Metal Yaylı Buton 6-24V DC - Halka		10	\$27,00
J22-C-271-RGBD	Ledli Metal Yaylı Buton 6-24V DC - Halka - RGB		10	\$31,40
J22-C-211	Metal Yaylı Buton - Işıksız		10	\$24,20



J22-C 22mm. Metal Kalıcı Butonlar IP67 6-24V DC 20A - 1NO

KOD	ÖZELLİK	RENK	PKT ADEDİ	FİYAT / ADET
J22-C-371-GD	Ledli Metal Kalıcı Buton 6-24V DC - Halka		10	\$29,20
J22-C-371-RD	Ledli Metal Kalıcı Buton 6-24V DC - Halka		10	\$29,20
J22-C-371-YD	Ledli Metal Kalıcı Buton 6-24V DC - Halka		10	\$29,20
J22-C-371-BD	Ledli Metal Kalıcı Buton 6-24V DC - Halka		10	\$29,20
J22-C-371-WD	Ledli Metal Kalıcı Buton 6-24V DC - Halka		10	\$29,20
J22-C-371-RGBD	Ledli Metal Kalıcı Buton 6-24V DC - Halka - RGB		10	\$33,50
J22-C-311	Metal Kalıcı Buton - Işıksız		10	\$26,40



M16mm SERİSİ PLASTİK YUVARLAK MANDAL BUTON

KOD	ÖZELLİK	KONTAK	PKT ADEDİ	FİYAT / ADET
M16-471	Ø16mm 0-1 Kalıcı Yuvarlak Mandal Buton	1NO+1NC	10	\$13,20
M16-572	Ø16mm 1-0-2 Kalıcı Yuvarlak Mandal Buton	2NO+2NC	10	\$16,00
M16-471K	Ø16mm 0-1 Kayıcı Yuvarlak Mandal Buton	1NO+1NC	10	\$13,20
M16-572K	Ø16mm 1-0-2 Kayıcı Yuvarlak Mandal Buton	2NO+2NC	10	\$16,00



M16mm SERİSİ PLASTİK KARE MANDAL BUTON

KOD	ÖZELLİK	KONTAK	PKT ADEDİ	FİYAT / ADET
M16-481	Ø16mm 0-1 Kalıcı Kare Mandal Buton	1NO+1NC	10	\$13,20
M16-582	Ø16mm 1-0-2 Kalıcı Kare Mandal Buton	2NO+2NC	10	\$16,00
M16-481K	Ø16mm 0-1 Kayıcı Kare Mandal Buton	1NO+1NC	10	\$13,20
M16-582K	Ø16mm 1-0-2 Kayıcı Kare Mandal Buton	2NO+2NC	10	\$16,00

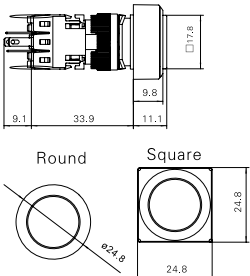

M16mm SERİSİ AKSEUAR

KOD	ÖZELLİK	PKT ADEDİ	FİYAT / ADET
M16-NO/NC	Kontakt Blok 1NO+1NC	10	\$3,40
M16KK	Terminal Koruyucu Kılıf	10	\$2,20
M16 ST	Soket Terminali	10	\$0,30
F16 CA	Çevirici Adaptör 220V - 24V	10	\$5,40

M16mm SERİSİ PLASTİK LEDLİ YUVARLAK SİNYAL

KOD	ÖZELLİK	RENK	PKT ADEDİ	FİYAT / ADET
M16-170W	Ø16mm Ledli Yuvarlak Sinyal 24VAC/DC	⊘	10	\$7,00
M16-170G	Ø16mm Ledli Yuvarlak Sinyal 24VAC/DC	●	10	\$7,00
M16-170Y	Ø16mm Ledli Yuvarlak Sinyal 24VAC/DC	●	10	\$7,00
M16-170R	Ø16mm Ledli Yuvarlak Sinyal 24VAC/DC	●	10	\$7,00



M16mm SERİSİ PLASTİK LEDLİ KARE SİNYAL

KOD	ÖZELLİK	RENK	PKT ADEDİ	FİYAT / ADET
M16-180W	Ø16mm Ledli Kare Sinyal 24VAC/DC	⊘	10	\$7,00
M16-180G	Ø16mm Ledli Kare Sinyal 24VAC/DC	●	10	\$7,00
M16-180Y	Ø16mm Ledli Kare Sinyal 24VAC/DC	●	10	\$7,00
M16-180R	Ø16mm Ledli Kare Sinyal 24VAC/DC	●	10	\$7,00



M16mm SERİSİ PLASTİK LEDLİ YUVARLAK YAYLI BUTON

KOD	ÖZELLİK	KONTAK	RENK	PKT ADEDİ	FİYAT / ADET
M16-211W	Ø16mm Ledli Yuvarlak Yaylı 24VAC/DC	1NO+1NC	⊘	10	\$11,50
M16-211G	Ø16mm Ledli Yuvarlak Yaylı 24VAC/DC	1NO+1NC	●	10	\$11,50
M16-211Y	Ø16mm Ledli Yuvarlak Yaylı 24VAC/DC	1NO+1NC	●	10	\$11,50
M16-211R	Ø16mm Ledli Yuvarlak Yaylı 24VAC/DC	1NO+1NC	●	10	\$11,50



M16mm SERİSİ PLASTİK LEDLİ KARE YAYLI BUTON

KOD	ÖZELLİK	KONTAK	RENK	PKT ADEDİ	FİYAT / ADET
M16-221W	Ø16mm Ledli Kare Yaylı 24VAC/DC	1NO+1NC	⊘	10	\$11,50
M16-221G	Ø16mm Ledli Kare Yaylı 24VAC/DC	1NO+1NC	●	10	\$11,50
M16-221Y	Ø16mm Ledli Kare Yaylı 24VAC/DC	1NO+1NC	●	10	\$11,50
M16-221R	Ø16 mm Ledli Kare Yaylı 24VAC/DC	1NO+1NC	●	10	\$11,50



M16mm SERİSİ PLASTİK LEDLİ YUVARLAK KALICI BUTON

KOD	ÖZELLİK	KONTAK	RENK	PKT ADEDİ	FİYAT / ADET
M16-311W	Ø16mm Ledli Yuvarlak Kalıcı 24VAC/DC	1NO+1NC	⊘	10	\$12,70
M16-311G	Ø16mm Ledli Yuvarlak Kalıcı 24VAC/DC	1NO+1NC	●	10	\$12,70
M16-311Y	Ø16mm Ledli Yuvarlak Kalıcı 24VAC/DC	1NO+1NC	●	10	\$12,70
M16-311R	Ø16mm Ledli Yuvarlak Kalıcı 24VAC/DC	1NO+1NC	●	10	\$12,70



M16mm SERİSİ PLASTİK LEDLİ KARE KALICI BUTON

KOD	ÖZELLİK	KONTAK	RENK	PKT ADEDİ	FİYAT / ADET
M16-321W	Ø16mm Ledli Kare Kalıcı 24VAC/DC	1NO+1NC	⊘	10	\$12,70
M16-321G	Ø16mm Ledli Kare Kalıcı 24VAC/DC	1NO+1NC	●	10	\$12,70
M16-321Y	Ø16mm Ledli Kare Kalıcı 24VAC/DC	1NO+1NC	●	10	\$12,70
M16-321R	Ø16mm Ledli Kare Kalıcı 24VAC/DC	1NO+1NC	●	10	\$12,70



W-200	W-201 (KIRMIZI)	W-201G (YEŞİL)	W-202	W-203 (KIRMIZI)	W-203G (YEŞİL)
2 PİN İŞİKSİZ MİNİ ANAHTAR	3 PİN İŞIKLI MİNİ ANAHTAR	3 PİN İŞIKLI MİNİ ANAHTAR	2 PİN İŞİKSİZ ANAHTAR	3 PİN İŞIKLI ANAHTAR	3 PİN İŞIKLI ANAHTAR
ON-OFF	ON-OFF	ON-OFF	ON-OFF	ON-OFF	ON-OFF
PAKET ADETİ:100	PAKET ADETİ:100	PAKET ADETİ:100	PAKET ADETİ:100	PAKET ADETİ:100	PAKET ADETİ:100
\$1,10	\$1,20	\$1,20	\$1,00	\$1,10	\$1,10

W-400 SİYAH	W-400 KIRMIZI	W-401	W-502	W-502G YEŞİL	W-502Y SARI
2 PİN İŞİKSİZ DAR TİP ANAHTAR	2 PİN İŞİKSİZ DAR TİP ANAHTAR	3 PİN İŞIKLI DAR TİP ANAHTAR	4 PİN İŞIKLI GENİŞ TİP ANAHTAR	4 PİN İŞIKLI GENİŞ TİP ANAHTAR	4 PİN İŞIKLI GENİŞ TİP ANAHTAR
ON-OFF	ON-OFF	ON-OFF	ON-OFF	ON-OFF	ON-OFF
PAKET ADETİ:100	PAKET ADETİ:100	PAKET ADETİ:100	PAKET ADETİ:100	PAKET ADETİ:100	PAKET ADETİ:100
\$0,90	\$0,90	\$1,00	\$1,20	\$1,20	\$1,20

W-502A	W-507	W-506	W-503R KIRMIZI	W-503G YEŞİL	W-503Y SARI
6 PİN İŞIKLI GENİŞ TİP ANAHTAR	6 PİN İŞIKLI 2.Lİ TİP ANAHTAR	9 PİN İŞIKLI 3'LÜ TİP ANAHTAR	4 PİN İŞIKLI GENİŞ TİP ANAHTAR	4 PİN İŞIKLI GENİŞ TİP ANAHTAR	4 PİN İŞIKLI GENİŞ TİP ANAHTAR
ON-OFF	ON-OFF	ON-OFF	KÖRÜKLÜ ON-OFF	KÖRÜKLÜ ON-OFF	KÖRÜKLÜ ON-OFF
PAKET ADETİ:100	PAKET ADETİ:50	PAKET ADETİ:50	PAKET ADETİ:50	PAKET ADETİ:50	PAKET ADETİ:50
\$2,00	\$1,90	\$3,30	\$3,50	\$3,50	\$3,50

KCD-4 SİYAH	KCD-4 RENKLİ	KCD-5	KCD-501	KCD-502	KCD-6
4 PİN GENİŞ TİP ANAHTAR	4 PİN GENİŞ TİP ANAHTAR	6 PİN GENİŞ TİP VİNÇ ANAHTARI	6 PİN GENİŞ TİP VİNÇ ANAHTARI	6 PİN İŞIKLI GENİŞ TİP ANAHTARI	4 PİN GENİŞ TİP ANAHTAR
ON-OFF	ON-OFF	ON-OFF-ON (İKİ TARAF YAYLI)	ON-OFF-ON (İKİ TARAF YAYLI)	ON-OFF-ON (İKİ TARAF KALICI)	TERMİKLİ ON-OFF
PAKET ADETİ:20	PAKET ADETİ:20	PAKET ADETİ:50	PAKET ADETİ:50	PAKET ADETİ:50	PAKET ADETİ:1
\$5,50	\$5,50	\$2,00	\$2,00	\$1,80	\$21,00

					
WS-1010	WS-1011	WS-1012	WIC-134M	WIC-185	PBS-12
KAPI SWITCH - 1NO	KAPI SWITCH - 1NC	KAPI SWITCH - 1NO+1NC	İŞIKLI MARİN SWITCH	12mm KALICI PLASTİK BUTON	12MM YAYLI PLASTİK BUTON
BASTIĞINDA AÇAR	BASTIĞINDA KAPATIR	KAPALIDIR-BASTIĞINDA AÇAR	12-24VDC	WIC-186	RENK BELİRTİNİZ LÜTFEN
PAKET ADETİ:100	PAKET ADETİ:100	PAKET ADETİ:100	PAKET ADETİ:10	12MM YAYLI PLASTİK BUTON	PAKET ADETİ:100
\$2,00	\$2,00	\$2,60	\$8,20	\$1,30	\$1,00

					
WIC-266H	WIC-266C	WIC-230D	WIC-240	WIC-240C	WIC-240B
PANO TİPİ RJ45 SOKET Ø22	PANO TİPİ USB KULAKSIZ Ø30mm	PANO TİPİ VOLTMETRE Ø28mm	BORN KLEMENS ORTA BOY	BORN KLEMENS ORTA BOY	BORN KLEMENS BÜYÜK BOY
IP67	GİRİŞ: 8-32V ÇIKIŞ: 5V 1A. - 5V 2A.	8V DC - 32VDC	*LÜTFEN RENK BELİRTİNİZ	*LÜTFEN RENK BELİRTİNİZ	*LÜTFEN RENK BELİRTİNİZ
PAKET ADETİ:10	PAKET ADETİ:10	PAKET ADETİ:10	PAKET ADETİ:100	PAKET ADETİ:100	PAKET ADETİ:100
\$16,50	\$18,50	\$16,50	\$0,60	\$0,40	\$0,75

					
WIC-238S	WIC-248	WIC-248A	WIC-248B	WIC-247	WIC-247A
BANAN JAK 2MM	KABLOSUZ KROKODİL	KABLOSUZ KROKODİL	KABLOSUZ KROKODİL	KABLOLU KROKODİL	KABLOLU KROKODİL
*LÜTFEN RENK BELİRTİNİZ	27.5MM BOY - KÜÇÜK	35MM BOY - ORTA	42.5MM BOY - BÜYÜK	27.5MM BOY - KÜÇÜK	42.5MM BOY - BÜYÜK
PAKET ADETİ:100	PAKET ADETİ:100	PAKET ADETİ:100	PAKET ADETİ:100	PAKET ADETİ:100	PAKET ADETİ:100
\$1,60	\$0,25	\$0,30	\$0,40	\$0,40	\$0,60

					
WIC-243A	WIC-243	WIC-244	WIC-245	WAM-01	WAM-02
BANAN JAK GİRİŞLİ KROKODİL	AKÜ MAŞASI KÜÇÜK BOY	AKÜ MAŞASI ORTA BOY	AKÜ MAŞASI BÜYÜK BOY	AKÜ MAŞASI EN BÜYÜK BOY	AKÜ MAŞASI EN BÜYÜK BOY
LÜTFEN RENK BELİRTİNİZ	66MM BOY	75MM BOY	100MM BOY	KIRMIZI	SİYAH
PAKET ADETİ:50	PAKET ADETİ:20	PAKET ADETİ:20	PAKET ADETİ:20	PAKET ADETİ:1	PAKET ADETİ:1
\$2,30	\$0,40	\$0,60	\$0,80	\$9,00	\$9,00

					
WIC-215A	WIC-215	WIC-212A	WIC-212	WIC-212D	WIC-213
POWER SOKET DIŐI SEYYAR	POWER SOKET ERKEK SEYYAR	POWER SOKET DIŐI KULAKLI	POWER SOKET ERKEK KULAKLI	POWER SOKET DIŐI KULAKSIZ	POWER SOKET ERKEK FUSELI KULAKLI
A KALİTE	A KALİTE	A KALİTE	A KALİTE	A KALİTE	A KALİTE
PAKET ADETİ:20	PAKET ADETİ:20	PAKET ADETİ:20	PAKET ADETİ:20	PAKET ADETİ:20	PAKET ADETİ:20
\$1,40	\$1,40	\$1,40	\$1,40	\$1,40	\$1,90

					
WRJ-11	WRJ-45	WRJ-45A	WRJ-45B	WIC-268	WRJ-11A
TELEFON KONNEKTÖRÜ	CAT5-CAT6 KONNEKTÖR	CAT5-CAT6 KONNEKTÖR UZATMA	CAT5-CAT6 KONNEKTÖR ÇOKLAYICI	POWER KABLO (ERKEK L - DIŐI DÜZ)	RJ-11 HAZIR TELEFON KABLOSU
4 PIN	8 PIN	DIŐİ+DIŐİ	2 PORT ÇOKLAYICI	1.5MT. KABLULU	6P4C 5MT.
PAKET ADETİ:100	PAKET ADETİ:100	PAKET ADETİ:20	PAKET ADETİ:20	PAKET ADETİ:1	PAKET ADETİ:1
\$0,40	\$0,45	\$0,80	\$1,60	\$6,50	\$2,25

					
WIC-161	WIC-161B	WIC-152-2	WIC-195	WIC-195A	WIC-195B
TOOGLE SWITCH KILIFI Ø12mm	TOOGLE SWITCH EMNİYET KAPAĐI	TOOGLE SWITCH	Ø12mm 0-1 ANAHTARLI SWITCH	Ø16mm 0-1 ANAHTARLI SWITCH	Ø16mm 0-1-2 ANAHTARLI SWITCH
WATER PROOF CAP	SİYAH - KIRMIZI *RENK BELİRTİNİZ	ON-OFF 2PIN	30MM BOY METAL	METAL	METAL
PAKET ADETİ:20	PAKET ADETİ:20	PAKET ADETİ:20	PAKET ADETİ:20	PAKET ADETİ:20	PAKET ADETİ:20
\$0,90	\$2,10	\$2,50	\$6,50	\$11,00	\$13,00

						
DK-215	DK-315	DK-315	DK-315	KTŞ-310	KTŞ-330	PTŞ
2X15A. POMPALI ŐALTER	3X15A. POMPALI ŐALTER	3X15A. POMPALI ŐALTER	3X15A. POMPALI ŐALTER	3x10A METAL GÖVDE	3x30A METAL GÖVDE	PAFTA TEZGAH ŐALTERİ
PAKET ADETİ:10	PAKET ADETİ:10	PAKET ADETİ:10	PAKET ADETİ:10	KUTULU TRİFAZE ŐALTER	KUTULU TRİFAZE ŐALTER	3x16A PLASTİK GÖVDE
				PAKET ADETİ:1	PAKET ADETİ:1	PAKET ADETİ:1
\$9,50	\$12,00	\$12,00	\$12,00	\$9,50	\$12,50	\$38,00

					
PT-11	PT-42	D-35 (DİAL KAFA)	PT-92	PT-94	WL5-PT.....K-M
TEK TURLU POTANSİYOMETRE	ÇOK TURLU POTANSİYOMETRE	TEK TURLU DİAL KAFA	ÇOK TURLU KÜÇÜK DİAL KAFA	ÇOK TURLU BÜYÜK DİAL KAFA	Ø22mm METAL KAPLAMALI
2W (5K-10K)	2W (5K-10K)	PLASTİK GÖVDEDİR	METAL GÖVDE	METAL GÖVDE	1K-2K-5K-10K POTANSİYOMETRE
PAKET ADETİ:10	PAKET ADETİ:10	PAKET ADETİ:10	PAKET ADETİ:10	PAKET ADETİ:1	*LÜTFEN K OHM BİLDİRİNİZ
\$5,50	\$15,00	\$3,20	\$21,00	\$31,50	\$11,80

					
KD-35	KD-50	KFK-1	KFK-2	KFK-3	KFK-4
35A. KÖPRÜ DİYOT	50A. KÖPRÜ DİYOT	KAPI FİŞ KONTAĞI	KAPI FİŞ KONTAĞI	KAPI FİŞ KONTAĞI	KAPI FİŞ KONTAĞI
PAKET ADETİ:50	PAKET ADETİ:50	PAKET ADETİ:10	PAKET ADETİ:10	PAKET ADETİ:10	PAKET ADETİ:10
\$2,40	\$4,00	\$8,60	\$8,60	\$8,60	\$8,60

					
FS-52	FS-63	FS-52M12	FS-63M14	M12SG5 - M12SG10	M12SG15 - M12SG20
5X20 CAM SİGORTA	6X30 CAM SİGORTA	5X20 CAM SİGORTA YUVASI	6X30 CAM SİGORTA YUVASI	5A-10A OTOMATİK MİNİ SİGORTA	15A - 20A OTOMATİK MİNİ SİGORTA
0.50 / 10A. SİGORTA AMPERİNİ BELİRTİLİNİZ	0.50 / 10A. SİGORTA AMPERİNİ BELİRTİLİNİZ			PAKET ADETİ:50	PAKET ADETİ:50
PAKET ADETİ:100	PAKET ADETİ:100	PAKET ADETİ:100	PAKET ADETİ:100	AMPER BELİRTİNİZ	AMPER BELİRTİNİZ
\$0,10	\$0,15	\$2,25	\$3,00	\$5,00	\$6,00

				
WIC-272	WIC-272-3	WTK-2	WTK-3	WTK-5
2'Lİ BASMALI KLEMENS	3'LÜ BASMALI KLEMENS	2'Lİ TIRNAKLI KLEMENS	3'Lİ TIRNAKLI KLEMENS	5'Lİ TIRNAKLI KLEMENS
PAKET ADETİ: 20	PAKET ADETİ: 20	PAKET ADETİ: 100	PAKET ADETİ: 100	PAKET ADETİ: 100
\$0,30	\$0,40	\$0,45	\$0,55	\$0,70



PORSELEN SİGORTA 8x31 gG YAVAŞ

KOD	ÖZELLİK	PKT ADEDİ	FİYAT / ADET
420500	Porselen Sigorta gG 8x31 0,5A	10	2,10 €
420501	Porselen Sigorta gG 8x31 1A	10	2,10 €
420502	Porselen Sigorta gG 8x31 2A	10	2,10 €
420504	Porselen Sigorta gG 8x31 4A	10	2,10 €
420506	Porselen Sigorta gG 8x31 6A	10	2,10 €
420508	Porselen Sigorta gG 8x31 8A	10	2,10 €
420510	Porselen Sigorta gG 8x31 10A	10	2,10 €
420512	Porselen Sigorta gG 8x31 12A	10	2,10 €
420516	Porselen Sigorta gG 8x31 16A	10	2,10 €
420720	Porselen Sigorta gG 8x31 20A	10	2,10 €



PORSELEN SİGORTA 10x38 gG YAVAŞ

KOD	ÖZELLİK	PKT ADEDİ	FİYAT / ADET
420000	Porselen Sigorta gG 10,3x38 0,5A	10	1,90 €
420001	Porselen Sigorta gG 10,3x38 1A	10	1,90 €
420002	Porselen Sigorta gG 10,3x38 2A	10	1,90 €
420004	Porselen Sigorta gG 10,3x38 4A	10	1,90 €
420006	Porselen Sigorta gG 10,3x38 6A	10	1,90 €
420008	Porselen Sigorta gG 10,3x38 8A	10	1,90 €
420010	Porselen Sigorta gG 10,3x38 10A	10	1,90 €
420012	Porselen Sigorta gG 10,3x38 12A	10	1,90 €
420016	Porselen Sigorta gG 10,3x38 16A	10	1,90 €
420020	Porselen Sigorta gG 10,3x38 20A	10	1,90 €
420025	Porselen Sigorta gG 10,3x38 25A	10	1,90 €
420032	Porselen Sigorta gG 10,3x38 32A	10	1,90 €



PORSELEN SİGORTA 14x51 gG YAVAŞ

KOD	ÖZELLİK	PKT ADEDİ	FİYAT / ADET
421001	Porselen Sigorta gG 14,3x51 1A	10	5,00 €
421002	Porselen Sigorta gG 14,3x51 2A	10	3,50 €
421004	Porselen Sigorta gG 14,3x51 4A	10	3,50 €
421006	Porselen Sigorta gG 14,3x51 6A	10	3,50 €
421008	Porselen Sigorta gG 14,3x51 8A	10	3,50 €
421010	Porselen Sigorta gG 14,3x51 10A	10	3,50 €
421012	Porselen Sigorta gG 14,3x51 12A	10	3,50 €
421016	Porselen Sigorta gG 14,3x51 16A	10	3,50 €
421020	Porselen Sigorta gG 14,3x51 20A	10	3,50 €
421025	Porselen Sigorta gG 14,3x51 25A	10	3,50 €
421032	Porselen Sigorta gG 14,3x51 32A	10	3,50 €
421040	Porselen Sigorta gG 14,3x51 40A	10	3,50 €
421050	Porselen Sigorta gG 14,3x51 50A	10	3,50 €

PORSELEN SİGORTA 22x58 gG YAVAŞ

KOD	ÖZELLİK	PKT ADEDİ	FİYAT / ADET
422002	Porselen sigorta gG 22,2X58 2A	10	8,50 €
422004	Porselen sigorta gG 22,2X58 4A	10	8,50 €
422006	Porselen sigorta gG 22,2X58 6A	10	8,50 €
422008	Porselen sigorta gG 22,2X58 8A	10	8,50 €
422010	Porselen sigorta gG 22,2X58 10A	10	8,50 €
422012	Porselen sigorta gG 22,2X58 12A	10	8,50 €
422016	Porselen sigorta gG 22,2X58 16A	10	6,00 €
422020	Porselen sigorta gG 22,2X58 20A	10	6,00 €
422025	Porselen sigorta gG 22,2X58 25A	10	6,00 €
422032	Porselen sigorta gG 22,2X58 32A	10	6,00 €
422040	Porselen sigorta gG 22,2X58 40A	10	6,00 €
422050	Porselen sigorta gG 22,2X58 50A	10	6,00 €
422063	Porselen sigorta gG 22,2X58 63A	10	6,00 €
422080	Porselen sigorta gG 22,2X58 80A		6,00 €
422000	Porselen sigorta gG 22,2X58 100A		6,00 €
422015	Porselen sigorta gG 22,2X58 125A		6,00 €



SİGORTA YUVALARI

KOD	ÖZELLİK	PKT ADEDİ	FİYAT / ADET
485001	Sigorta yuvası PM F 8X31 1P	10	9,50 €
485101	Sigorta yuvası PM F 10X38 1P	10	8,00 €
485104	Sigorta yuvası PM F 10X38 2P	10	14,50 €
485105	Sigorta yuvası PM F 10X38 3P (ÜÇLÜ)	10	23,00 €
485201	Sigorta yuvası PM-X 14X51 1P	10	14,50 €
485204	Sigorta yuvası PM-X 14X51 2P (İKİLİ)	10	30,00 €
485205	Sigorta yuvası PM-X 14X51 3P (ÜÇLÜ)	10	49,00 €
485301	Sigorta yuvası PM-X 22X58 1P	10	29,00 €
485304	Sigorta yuvası PM-X 22X58 2P (İKİLİ)	10	60,00 €
485305	Sigorta yuvası PM-X 22X58 3P (ÜÇLÜ)	10	89,00 €





WLPLC RÖLE VE SOKET (6mm) ve ÜST KÖPRÜ					
KOD	ÖZELLİK	VOLTAJ	PKT ADEDİ	FİYAT / ADET	
WLPLC-12R	6A. Röle + Vidalı Soket Tk. 1NO	12V DC	20	\$10,50	
WLPLC-24R	6A. Röle + Vidalı Soket Tk. 1NO	24V DC	20	\$10,50	
WLPLC-220R	6A. Röle + Vidalı Soket Tk. 1NO	220V AC	20	\$15,50	
WLPLC-ÜST KÖPRÜ	Plc Röle Soket Üst Köprü (Diğer Plc Modellerine Uygundur.)		20	\$3,70	



WLPLC-ÜSTKÖPRÜ



WLRL-41 RÖLE VE SOKET 5 PİN 1 KONTAK 5A					
KOD	ÖZELLİK	VOLTAJ	PKT ADEDİ	FİYAT / ADET	
WLRL-41 12VDC	5 Pin 1 Kontak Röle	12V DC	25	\$4,50	
WLRL-41 24VDC	5 Pin 1 Kontak Röle	24V DC	25	\$4,20	
WLRL-41 220VAC	5 Pin 1 Kontak Röle	220V AC	25	\$9,50	
WLSC-41	5 Pin Ray Montaj Kısa Tip Soket	12A 300V	20	\$4,20	



WLRL-42 RÖLE VE SOKET 8 PİN 2 KONTAK 5A					
KOD	ÖZELLİK	VOLTAJ	PKT ADEDİ	FİYAT / ADET	
WLRL-42 12VDC	8 Pin 2 Kontak Röle	12V DC	25	\$4,50	
WLRL-42 24VDC	8 Pin 2 Kontak Röle	24V DC	25	\$4,20	
WLRL-42 220VAC	8 Pin 2 Kontak Röle	220V AC	25	\$9,50	
WLSC-42	8 Pin Ray Montaj Kısa Tip Soket	12A 300V	20	\$4,20	



WLRL-157-5P RÖLE VE SOKET 5 PİN 1 KONTAK 12A					
KOD	ÖZELLİK	VOLTAJ	PKT ADEDİ	FİYAT / ADET	
WLRL-157-5P-24VDC	5 Pin 1 Kontak Röle	24V DC	25	\$7,50	
WLRL-157-5P-220VAC	5 Pin 1 Kontak Röle	220V AC	25	\$9,50	
WLSC-157-5P	5 Pin Ray Montaj Uzun Tip Soket	12A 300V	20	\$7,50	



WLRL-157-8P RÖLE VE SOKET 8 PİN 2 KONTAK 8A					
KOD	ÖZELLİK	VOLTAJ	PKT ADEDİ	FİYAT / ADET	
WLRL-157-8P-12VDC	8 Pin 2 Kontak Röle	12V DC	25	\$7,50	
WLRL-157-8P-24VDC	8 Pin 2 Kontak Röle	24V DC	25	\$7,50	
WLRL-157-8P-220VAC	8 Pin 2 Kontak Röle	220V AC	25	\$9,50	
WLSC-157-8P	8 Pin Ray Montaj Uzun Tip Soket	12A 300V	20	\$7,50	

WLRL-52 RÖLE VE SOKET 8 PİN 2 KONTAK 10A

KOD	ÖZELLİK	VOLTAJ	PKT ADEDİ	FİYAT / ADET
WLRL-52 12VDC	8 Pin 2 Kontak Röle	12V DC	25	\$8,80
WLRL-52 24VDC	8 Pin 2 Kontak Röle	24V DC	25	\$8,80
WLRL-52 220VAC	8 Pin 2 Kontak Röle	220 VAC	25	\$8,80
WLSC-52	8 Pin Ray Montaj Kısa Tip Soket	12A 300V	20	\$4,90



WLRL-53 RÖLE VE SOKET 11 PİN 3 KONTAK 10A

KOD	ÖZELLİK	VOLTAJ	PKT ADEDİ	FİYAT / ADET
WLRL-53 12VDC	11 Pin 3 Kontak Röle	12V DC	20	\$8,80
WLRL-53 24VDC	11 Pin 3 Kontak Röle	24V DC	20	\$8,80
WLRL-53 220VAC	11 Pin 3 Kontak Röle	220V AC	20	\$8,80
WLSC-53	11 Pin Ray Montaj Kısa Tip Soket	12A 300V	20	\$4,90



WLRL-54 RÖLE VE SOKET 14 PİN 4 KONTAK 5A

KOD	ÖZELLİK	VOLTAJ	PKT ADEDİ	FİYAT / ADET
WLRL-54 12VDC	14 Pin 4 Kontak Röle	12V DC	20	\$8,80
WLRL-54 24VDC	14 Pin 4 Kontak Röle	24V DC	20	\$8,80
WLRL-54 220VAC	14 Pin 4 Kontak Röle	220V AC	20	\$8,80
WLSC-54	14 Pin Ray Montaj Kısa Tip Soket	12A 300V	20	\$4,90
WLSC-54D	14 Pin Ray Montaj Uzun Tip Soket	12A 300V	20	\$5,30



LED BLOĞU

KOD	ÖZELLİK	VOLTAJ	PKT ADEDİ	FİYAT / ADET
RL-LB24	8 Pin Röle Soket Led Bloğu	24V DC	100	\$3,00
RL-LB220	8 Pin Röle Soket Led Bloğu	220V AC	100	\$3,40



ACN-48 220



AMS-11-24



ASD-22



SAYICILAR

KOD	ÖZELLİK	ADET	FİYAT / ADET
ASD-22 220 (NPN)	6 Haneli Dijital Sayıcı Npn Sensör Girişli Hafızalı 220V AC	1	\$32,00
ASD-22 24 (NPN)	6 Haneli Dijital Sayıcı Npn Sensör Girişli Hafızalı 24V AC/DC	1	\$32,00
ASD-22 220 (PNP)	6 Haneli Dijital Sayıcı Pnp Sensör Girişli Hafızalı 220V AC	1	\$32,00
ASD-22 24 (PNP)	6 Haneli Dijital Sayıcı Pnp Sensör Girişli Hafızalı 24V AC/DC	1	\$32,00
ACN-48 220	7 Haneli Mekanik İş-Güç Zaman Saati 220V AC	1	\$25,00
AMS-11-24	6 Haneli Mekanik Sayıcı 24V AC/DC	1	\$35,00
AMS-11-220	6 Haneli Mekanik Sayıcı 220V AC	1	\$35,00



LED TRAFOSU (İÇ MEKAN)

KOD	GÜÇ	AC	VDC	AMPER	FİYAT / ADET
KS-15 12	15W	85-264V	12VDC	1,3A	\$23,60
KS-25 12	25W	85-264V	12VDC	2,1A	\$27,20
KS-35 12	36W	85-264V	12VDC	3A	\$34,60
KS-50 12	50W	85-264V	12VDC	4,2A	\$33,00
KS-60 12	60W	85-264V	12VDC	5A	\$36,00
KS-75 12	75W	85-264V	12VDC	6A	\$37,00
KS-100 12	100W	85-264V	12VDC	8,5A	\$41,00
KS-120 12	120W	85-264V	12VDC	10A	\$44,00
KS-150 12	150W	85-264V	12VDC	12,5A	\$58,50
KS-200 12	200W	85-264V	12VDC	16,5A	\$81,00
KS-270 12	270W	85-264V	12VDC	22,5A	\$95,00
KS-350 12	350W	176-264V	12VDC	29A	\$105,00

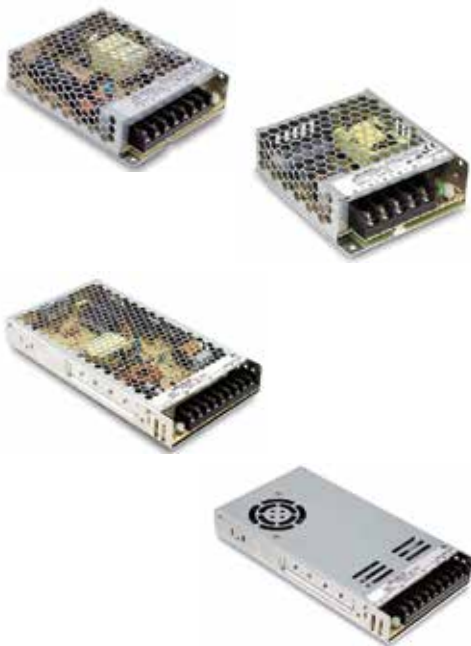

KAPALI TİP GÜÇ KAYNAĞI

KOD	GÜÇ	AC	VDC	AMPER	FİYAT / ADET
KS-15 24	15W	85-264V	24VDC	0,7A	\$24,00
KS-25 24	25W	85-264V	24VDC	1,1A	\$27,20
KS-35 24	36W	85-264V	24VDC	1,5A	\$33,00
KS-50 24	50W	85-264V	24VDC	2,2A	\$32,00
KS-60 24	60W	85-264V	24VDC	2,5A	\$34,00
KS-75 24	75W	85-264V	24VDC	3,2A	\$38,00
KS-100 24	100W	85-264V	24VDC	4,5A	\$41,00
KS-120 24	120W	85-264V	24VDC	5A	\$50,00
KS-150 24	150W	85-264V	24VDC	6,5A	\$58,50
KS-200 24	200W	85-264V	24VDC	8,3A	\$81,00
KS-270 24	270W	85-264V	24VDC	11,25A	\$95,00
KS-350 24	350W	85-264V	24VDC	14,6A	\$105,00
KS-500 24	500W	176-264V	24VDC	20A	\$270,00

MDR SERİSİ (RAYA MONTAJ)

KOD	GÜÇ	AC	VDC	AMPER	FİYAT / ADET
MDR-10-12	10W	85-264V	12VDC	0,84A	\$40,00
MDR-10-24	10W	85-264V	24VDC	0,42A	\$40,00
MDR-20-12	20W	85-264V	12VDC	1,67A	\$41,00
MDR-20-24	20W	85-264V	24VDC	1A	\$41,00
MDR-40-12	40W	85-264V	12VDC	3,33A	\$57,50
MDR-40-24	40W	85-264V	24VDC	1,70A	\$57,50
MDR-60-12	60W	85-264V	12VDC	5A	\$58,50
MDR-60-24	60W	85-264V	24VDC	2,5A	\$58,50
MDR-100-12	100W	85-264V	12VDC	7,5A	\$102,00
MDR-100-24	100W	85-264V	24VDC	4A	\$102,00



EDR SERİSİ (RAYA MONTAJ)

KOD	GÜÇ	AC	VDC	AMPER	FİYAT / ADET
EDR-75-12	75W	90-264V	12VDC	6,3A	\$74,00
EDR-75-24	75W	90-264V	24VDC	3,2A	\$74,00
EDR-120-12	120W	90-264V	12VDC	10A	\$90,00
EDR-120-24	120W	90-264V	24VDC	5A	\$90,00
EDR-150-24	150W	90-264V	24VDC	6,5A	\$83,00



NDR SERİSİ (RAYA MONTAJ)

KOD	GÜÇ	AC	VDC	AMPER	FİYAT / ADET
NDR-240-24	240W	90-264V	24VDC	10A	\$150,50
NDR-240-48	240W	90-264V	48VDC	5A	\$150,50
NDR-480-24	480W	90-264V	24VDC	20A	\$325,00
NDR-480-48	480W	90-264V	48VDC	10A	\$325,00





WS-1011



WS-1012

BUTON SWITCH

KOD	ÖZELLİK	PKT ADEDİ	FİYAT / ADET
WS-1010	Ani Hareketli Switch 1NO (1NA)	100	\$2,00
WS-1011	Ani Hareketli Switch 1NC (1NK)	100	\$2,00
WS-1012	Ani Hareketli Switch 1NO+1NC (1NA+1NK)	100	\$2,60



MPP-1



RMP-UPS-LEDLİ



RMP-LEDLİ

MADE IN TURKEY



*TÜRK PATENT VE MARKA KURUMU "TR202001094Y" Faydalı Model Patentine Sahiptir.

PANO PRİZLERİ

KOD	ÖZELLİK	PKT ADEDİ	FİYAT / ADET
MPP-1	Pano Prizi (Mavi Kapaklı)	40	\$2,50
RMP	Raya Montaj Pano İçi Priz 1x16A	10	\$6,50
RMP-LEDLİ	Raya Montaj Pano İçi Priz - Ledli 1x16A	10	\$7,00
RMP-UPS	Raya Montaj Pano İçi Priz - UPS'li (Fransız Tipi) 1x16A	10	\$7,00
RMP-UPS-LEDLİ	Raya Montaj Pano İçi Priz - UPS'li+Ledli (Fransız Tipi) 1x16A	10	\$8,00

TPM-0P0070



TPM-1P0070



PFT-26S



PFT-26I



PFT-26SI



PANO TERMOSTAT

KOD	ÖZELLİK	PKT ADEDİ	FİYAT / ADET
TPM-0P0070	BLAUBERG 70°C Pano Isıtma - Raya Montaj Termostat	10	\$9,50
TPM-1P0070	BLAUBERG 70°C Pano Soğutma - Raya Montaj Termostat	10	\$9,50
PFT-26 I	Pano Isıtma - Raya Montaj Termostat 60°C	10	\$9,00
PFT-26 S	Pano Soğutma - Raya Montaj Termostat 10°C	10	\$9,00
PFT-26 SI	Pano Isıtma + Soğutma - Raya Montaj Termostat 60°C /10°C	10	\$18,00

ORS-ST



OR-D



OR-S1



OTOMAT RAYI ve AKSESUARLARI

KOD	ÖZELLİK	PKT ADEDİ	FİYAT / ADET
ORS-ST	Sac Ray Taşıyıcı	100	\$0,75
OR-D	Ray Distans	100	\$0,50
OR-S1	Delikli W Otomat Rayı 1 Mt. 35x7,5 Standart	50	\$2,50
OR-S2	Delikli W Otomat Rayı 2 Mt. 35x7,5 Standart	20	\$5,00

SALZER METAL FAN

KOD	ÖZELLİK	ÖLÇÜ	PKT ADEDİ	FİYAT / ADET
FAN-21	Metal Kare Fan 230V AC	120x120x38	1	\$21,00
FAN-33	Metal Fan 230V AC	172x150x51	1	\$65,00
FAN-40	Metal Kare Fan 24V DC	120x120x38	1	\$21,00
FAN-58	Metal Fan 24V DC	172x150x51	1	\$65,00



METAL KARE FAN

KOD	ÖZELLİK	ÖLÇÜ	PKT ADEDİ	FİYAT / ADET
PF-80-24	Metal Kare Fan 24V DC	80x80x25	1	\$10,00
PF-80-220	Metal Kare Fan 220V AC	80x80x25	1	\$12,50
PF-92-24	Metal Kare Fan 24V DC	92x92x38	1	\$12,50
PF-92-220	Metal Kare Fan 220V AC	92x92x38	1	\$12,50
PF-120-24	Metal Kare Fan 24V DC	120x120x38	1	\$12,50
PF-120-220	Metal Kare Fan 220V AC	120x120x38	1	\$12,50
PF-150-24	Metal Kare Fan 24V DC	172x150x50	1	\$40,00
PF-150-220	Metal Kare Fan 220V AC	172x150x50	1	\$40,00
PF-172-24	Metal Kare Fan 24V DC	172x163x51	1	\$49,00
PF-172-220	Metal Kare Fan 220V AC	172x163x51	1	\$49,00

FAN FİLTRESİ

KOD	ÖZELLİK	PKT ADEDİ	FİYAT / ADET
FF-80 P	Fan Filtresi (Davlumbazsız) 80x80	10	\$4,00
FF-92 P	Fan Filtresi (Davlumbazsız) 92x92	10	\$4,20
FF-120 P	Fan Filtresi (Davlumbazsız) 120x120	10	\$4,20
FF-250 P	Fan Filtresi (Davlumbazsız) 250x250	10	\$14,00



METAL FAN TELİ

KOD	ÖZELLİK	PKT ADEDİ	FİYAT / ADET
MFT-80	Metal Fan Teli 80x80	10	\$1,40
MFT-92	Metal Fan Teli 92x92	10	\$1,50
MFT-120	Metal Fan Teli 120x120	10	\$1,50
MFT-150	Metal Fan Teli 150x172	10	\$2,90

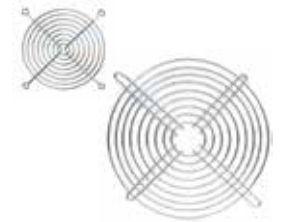

T5 LEDLİ BANT ARMATÜR

KOD	GÜÇ	ÖLÇÜ	LÜMEN	RENK	PKT ADEDİ	FİYAT / ADET
LBA-5W	5W	5W 30 cm Pano Armatürü	6500K	Beyaz	1	\$8,00
LBA-5W-M	5W	5W 30 cm Mıknatıslı Pano Armatürü	6500K	Beyaz	1	\$10,50
LBA-5W-MK	5W	5W 30 cm Kablolu&Mıknatıslı Pano Armatürü	6500K	Beyaz	1	\$12,00
LBA-8W	8W	8W 60 cm Pano Armatürü	6500K	Beyaz	1	\$11,50



İZOLELİ TEK GİRİŞ YÜKSÜKLER - BAKIR

KOD	RENK NORMU		KABLO KESİTİ	F	L	KUTU ADET	KUTULU FİYAT
	FRANSIZ	ALMAN					
TRM-IY 0.25			0.25mm	8.0	12.0	1000	\$0,030
TRM-IY 0.34			0.34 mm	8.0	12.0	1000	\$0,025
TRM-IY 0.50			0.50 mm	8.0	14.0	1000	\$0,015
TRM-IY 0.75			0.75 mm	8.0	14.0	1000	\$0,015
TRM-IY 1.0			1.0 mm	8.0	14.0	1000	\$0,015
TRM-IY 1.5			1.5 mm	8.0	14.0	1000	\$0,020
TRM-IY 2.5			2.5 mm	8.0	14.0	500	\$0,025
TRM-IY 4.0			4.0 mm	10.0	17.0	500	\$0,035
TRM-IY 6.0			6.0 mm	12.0	20.0	250	\$0,040
TRM-IY 10			10 mm	12.0	22.0	100	\$0,060
TRM-IY 16			16 mm	12.0	24.0	100	\$0,080
TRM-IY 25			25 mm	16.0	30.0	50	\$0,130
TRM-IY 35			35 mm	16.0	30.0	50	\$0,160
TRM-IY 50			50 mm	20.0	36.0	25	\$0,300
TRM-IY 70			70 mm	21.0	37.0	25	\$0,500























İZOLELİ ÇİFT GİRİŞ YÜKSÜKLER - BAKIR

KOD	RENK NORMU		KABLO KESİTİ	F	L	KUTU ADET	KUTULU FİYAT
	FRANSIZ	ALMAN					
TRM-CY 0.50			2x0.50 mm	8.0	15.0	1000	\$0,030
TRM-CY 0.75			2x0.75 mm	8.0	15.0	500	\$0,030
TRM-CY 1.0			2x1.0 mm	8.0	15.0	500	\$0,030
TRM-CY 1.5			2x1.5 mm	8.0	16.0	500	\$0,040
TRM-CY 2.5			2x2.5 mm	10.0	18.5	250	\$0,050
TRM-CY 4.0			2x4.0 mm	12.0	23.0	200	\$0,070
TRM-CY 6.0			2x6.0 mm	14.0	26.0	100	\$0,085
TRM-CY 10			2x10 mm	14.0	26.5	100	\$0,130
TRM-CY 16			2x16 mm	14.0	31.5	50	\$0,170



İZOLELİ YUVARLAK KABLO UÇLARI

KOD	KABLO KESİTİ	KABLO GİRİŞ	SOKET GENİŞLİĞİ	RENK	PKT ADEDİ	FİYAT / ADET
YU-301	0.50 ~ 1.5 mm ² 22 ~ 16 AWG		M 3		200	\$0,055
YU-401			M 4		200	\$0,055
YU-501			M 5		200	\$0,060
YU-601			M 6		200	\$0,075
YU-801			M 8		200	\$0,080
YU-302	1.5 ~ 2.5 mm ² 16 ~ 14 AWG		M 3		200	\$0,060
YU-402			M 4		200	\$0,070
YU-502			M 5		200	\$0,065
YU-602			M 6		200	\$0,080
YU-802			M 8		200	\$0,095
YU-1002	4.6 ~ 6.0 mm ² 16 ~ 14 AWG		M 10		100	\$0,105
YU-1202			M 12		100	\$0,190
YU-406			M 4		100	\$0,115
YU-506			M 5		100	\$0,125
YU-606			M 6		100	\$0,130
YU-806	M 8		100	\$0,155		
YU-1006	M 10		100	\$0,180		
YU-1206	M 12		100	\$0,205		



İZOLELİ ÇATAL KABLO UÇLARI

KOD	KABLO KESİTİ	KABLO GİRİŞ	SOKET GENİŞLİĞİ	RENK	PKT ADEDİ	FİYAT / ADET
ÇU-3001	0.50 ~ 1.5 mm ²		M 3	●	200	\$0,050
ÇU-4001			M 4	●	200	\$0,060
ÇU-5001			M 5	●	200	\$0,065
ÇU-6001			M 6	●	200	\$0,080
ÇU-3002	1.5 ~ 2.5 mm ²		M 3	●	200	\$0,065
ÇU-4002			M 4	●	200	\$0,070
ÇU-5002			M 5	●	200	\$0,075
ÇU-6002			M 6	●	200	\$0,080
ÇU-4006	4.6 ~ 6.0 mm ²		M 4	●	100	\$0,100
ÇU-5006			M 5	●	100	\$0,105
ÇU-6006			M 6	●	100	\$0,135
ÇU-8006			M 8	●	100	\$0,155



İZOLELİ ERKEK FASTON KABLO UÇLARI

KOD	KABLO KESİTİ	RENK	PKT ADEDİ	FİYAT / ADET
FE-1288	2,8 0,50-1,5mm İzoleli Erkek Faston Kablo Uçları	●	200	\$0,070
FE-1488	4,8 0,50-1,5mm İzoleli Erkek Faston Kablo Uçları	●	200	\$0,085
FE-1638	6,3 0,50-1,5mm İzoleli Erkek Faston Kablo Uçları	●	200	\$0,095
FE-2288	2,8 1,5-2,5mm İzoleli Erkek Faston Kablo Uçları	●	200	\$0,085
FE-2488	4,8 1,5-2,5mm İzoleli Erkek Faston Kablo Uçları	●	200	\$0,090
FE-2638	6,3 1,5-2,5mm İzoleli Erkek Faston Kablo Uçları	●	200	\$0,095
FE-5638	6,3 4-6mm İzoleli Erkek Faston Kablo Uçları	●	100	\$0,150



İZOLELİ DIŞI FASTON KABLO UÇLARI

KOD	KABLO KESİTİ	RENK	PKT ADEDİ	FİYAT / ADET
FD-1288	2,8 0,50-1,5mm İzoleli Dişi Faston Kablo Uçları	●	200	\$0,070
FD-1488	4,8 0,50-1,5mm İzoleli Dişi Faston Kablo Uçları	●	200	\$0,075
FD-1638	6,3 0,50-1,5mm İzoleli Dişi Faston Kablo Uçları	●	200	\$0,095
FD-2288	2,8 1,5-2,5mm İzoleli Dişi Faston Kablo Uçları	●	200	\$0,080
FD-2488	4,8 1,5-2,5mm İzoleli Dişi Faston Kablo Uçları	●	200	\$0,080
FD-2638	6,3 1,5-2,5mm İzoleli Dişi Faston Kablo Uçları	●	200	\$0,100
FD-5638	6,3 4-6mm İzoleli Dişi Faston Kablo Uçları	●	150	\$0,200



TAM İZOLELİ DIŞI FASTON KABLO UÇLARI

KOD	KABLO KESİTİ	RENK	PKT ADEDİ	FİYAT / ADET
FFD-1288	2,8 0,50-1,5mm Tam İzoleli Dişi Faston Kablo Uçları	●	200	\$0,090
FFD-1488	4,8 0,50-1,5mm Tam İzoleli Dişi Faston Kablo Uçları	●	200	\$0,090
FFD-1638	6,3 0,50-1,5mm Tam İzoleli Dişi Faston Kablo Uçları	●	200	\$0,120
FFD-2288	2,8 1,5-2,5mm Tam İzoleli Dişi Faston Kablo Uçları	●	200	\$0,110
FFD-2488	4,8 1,5-2,5mm Tam İzoleli Dişi Faston Kablo Uçları	●	200	\$0,100
FFD-2638	6,3 1,5-2,5mm Tam İzoleli Dişi Faston Kablo Uçları	●	200	\$0,120
FFD-5638	6,3 4-6mm Tam İzoleli Dişi Faston Kablo Uçları	●	100	\$0,140



İZOLESİZ TERMİNERLER

KOD	ÖZELLİK	PKT ADEDİ	FİYAT / ADET
SF-1D	6.3 Dişi Terminal	300	\$0,040
SF-2D	6.3 Dişi Tırnaklı Terminal	300	\$0,040
SF-3D	9.5 Dişi Terminal	100	\$0,100
SF-1/2D	2.8 Dişi Terminal	1000	\$0,020
SF-1D Mini	4.8 Dişi Terminal	500	\$0,030
SF-1D Kılıfı	6.3 Terminal Kılıfı	300	\$0,020
SF-2D Kılıfı	6.3 Tırnaklı Terminal Kılıfı	500	\$0,025
SF-1EÇK	6.3 Erkek Terminal	300	\$0,040
SF-1EU1	6.3 Erkek Terminal	300	\$0,050
SKN-2,5	M4 Topraklama Terminali	500	\$0,040
SKN-4	M5 Topraklama Terminali	250	\$0,080
SKN-6	M6 Topraklama Terminali	150	\$0,100
SK-2,5	M4 Topraklama Terminali	1000	\$0,045
SK-4	M5 Topraklama Terminali	500	\$0,070
SK-6	M6 Topraklama Terminali	250	\$0,080



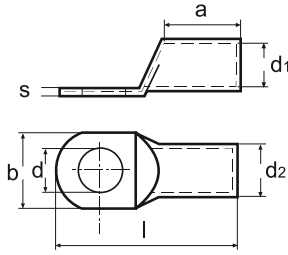

STANDART TİP KABLO PABUÇLARI

KOD	KABLO KESİTİ (mm ²)	METRİK (Ø)	ÖLÇÜLER		KUTU AĞIRLIĞI (~kg)	KUTU ADEDİ	FİYAT / ADET
			d	L			
ST 01005	10 mm ²	M5	5,5	27,5	2,80	800	\$0,51
ST 01006		M6	6,5	27,5	2,60	800	\$0,54
ST 01008		M8	8,5	30,5	2,80	800	\$0,54
ST 01605	16 mm ²	M5	5,5	29,5	2,60	500	\$0,72
ST 01606		M6	6,5	29,5	2,70	500	\$0,72
ST 01608		M8	8,5	33,0	2,90	500	\$0,76
ST 01610		M10	10,5	33,5	2,90	500	\$0,90
ST 02506	25 mm ²	M6	6,5	39,0	3,00	300	\$1,22
ST 02508		M8	8,5	39,0	2,75	300	\$1,20
ST 02510		M10	10,5	42,0	2,90	300	\$1,30
ST 02512		M12	13,0	45,0	2,90	300	\$1,45
ST 03506	35 mm ²	M6	6,5	44,0	2,80	200	\$1,60
ST 03508		M8	8,5	44,0	2,80	200	\$1,60
ST 03510		M10	10,5	48,0	2,80	200	\$1,60
ST 03512		M12	13,0	48,0	2,80	200	\$1,83
ST 05006	50 mm ²	M6	6,5	47,5	3,00	150	\$2,45
ST 05008		M8	8,5	47,5	3,10	150	\$2,45
ST 05010		M10	10,5	51,5	3,30	150	\$2,45
ST 05012		M12	13,0	51,5	3,10	150	\$2,65
ST 05014		M14	15,0	56,5	3,30	150	\$2,90
ST 07008	70 mm ²	M6	8,5	50,6	2,80	100	\$3,34
ST 07010		M8	10,5	54,6	3,00	100	\$3,34
ST 07012		M10	13,0	54,6	2,80	100	\$3,45
ST 07014		M12	15,0	62,6	3,40	100	\$4,20
ST 07016		M16	17,0	62,6	3,20	100	\$4,20
ST 09508	95 mm ²	M8	8,5	58,8	3,00	80	\$3,76
ST 09510		M10	10,5	58,8	3,00	80	\$3,52
ST 09512		M12	13,0	58,8	2,90	80	\$3,52
ST 09514		M14	15,0	66,8	3,20	80	\$4,80
ST 09516		M16	17,0	66,8	3,10	80	\$4,80
ST 12010	120 mm ²	M10	10,5	69,0	2,70	50	\$5,10
ST 12012		M12	13,0	69,0	2,60	50	\$5,10
ST 12014		M14	15,0	69,0	2,50	50	\$5,10
ST 12016		M16	17,0	69,0	2,40	50	\$5,25
ST 12020		M20	21,0	69,0	2,10	50	\$5,35
ST 15010	150 mm ²	M10	10,5	76,5	2,60	30	\$8,15
ST 15012		M12	13,0	76,5	2,50	30	\$7,90
ST 15014		M14	15,0	76,5	2,40	30	\$7,90
ST 15016		M16	17,0	76,5	2,40	30	\$8,25
ST 18510	185 mm ²	M10	10,5	82,5	3,00	30	\$8,95
ST 18512		M12	13,0	82,5	3,00	30	\$8,95
ST 18514		M14	15,0	82,5	2,90	30	\$8,95
ST 18516		M16	17,0	82,5	2,90	30	\$8,95
ST 24010	240 mm ²	M10	10,5	89,0	3,00	25	\$12,50
ST 24012		M12	13,0	89,0	3,00	25	\$12,30
ST 24014		M14	15,0	89,0	2,90	25	\$12,30
ST 24016		M16	17,0	89,0	2,90	25	\$12,30
ST 30012	300 mm ²	M12	23,4	95,0	3,50	20	\$15,65
ST 30014		M14	23,4	95,0	3,40	20	\$15,65
ST 30016		M16	23,4	95,0	3,20	20	\$15,65

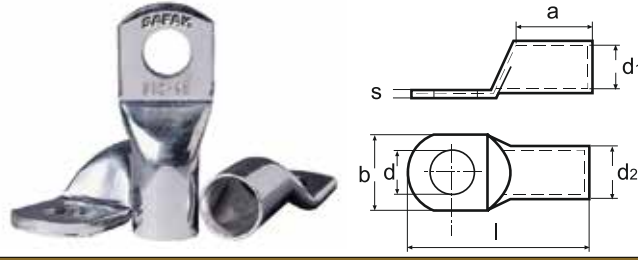

EKO TİP SIKMALI KABLO PABUÇLARI

KOD	KABLO KESİTİ (mm ²)	METRİK (Ø)	ÖLÇÜLER								KUTU AĞIRLIĞI (~kg)	KUTU ADEDİ	FİYAT / ADET
			d	d1	d2	l1	a	b	c1	c2			
E 01005	10mm ²	M5	5,3	4,5	6,0	21,5	9,0	8,6	5,5	7,0	2,10	800	\$0,35
E 01606	16mm ²	M6	6,4	5,5	7,0	24,5	11,0	10,5	5,5	6,5	1,70	500	\$0,40
E 02508	25mm ²	M8	8,3	7,0	9,0	31,7	12,0	13,0	6,8	9,2	2,20	300	\$0,85
E 03508	35mm ²	M8	8,3	8,5	10,5	35,2	14,0	15,5	8,3	9,7	2,00	200	\$1,30
E 05010	50mm ²	M10	8,3	10,0	12,0	41,5	17,0	17,9	10,0	12,0	2,20	150	\$1,55
E 07010	70mm ²	M10	10,3	11,5	14,0	45,5	18,0	20,7	10,0	12,0	2,30	100	\$2,40
E 09510	95mm ²	M10	10,3	13,5	16,0	48,5	21,0	23,5	10,0	12,0	2,20	80	\$2,75
E 12012	120mm ²	M12	12,8	15,5	18,0	58,0	25,0	26,7	13,0	14,5	1,90	50	\$3,80
E 15012	150mm ²	M12	12,8	16,5	20,0	59,5	26,0	29,2	16,5	16,5	2,10	30	\$5,95
E 18516	185mm ²	M16	16,5	18,5	22,0	65,0	29,0	32,3	17,0	18,0	2,15	30	\$6,50
E 24016	240mm ²	M16	16,5	21,5	25,5	74,0	33,0	37,6	17,0	18,0	2,70	25	\$8,95



*Sertleştirilmiş Alüminyum Bağlantı Yüzeyi Sıkma İşleminde Sonra Gevşeme Yapmaz

ALÜMİNYUM SKP

KOD	KABLO KESİTİ (mm ²)	METRİK (Ø)	ÖLÇÜLER					KUTU ADEDİ	FİYAT / ADET
			D	d	L	L1	B		
SKP-AL50	50mm ²	M8	16,0	10,0	90,0	42,0	23,0	20	\$0,95
SKP-AL70	70mm ²	M10	18,0	11,5	100,0	47,0	26,0	10	\$1,40
SKP-AL95	95mm ²	M12	21,0	13,5	112,0	50,0	28,0	10	\$1,85
SKP-AL120	120mm ²	M12	23,0	15,0	120,0	53,0	30,0	10	\$2,20
SKP-AL150	150mm ²	M12	25,0	16,5	126,0	55,0	34,0	10	\$2,65
SKP-AL185	185mm ²	M14	27,0	18,5	133,0	58,0	37,0	10	\$3,25
SKP-AL240	240mm ²	M16	30,0	21,0	140,0	60,0	40,0	10	\$4,85

*SKP-SR1, alüminyum yüzeylerde oksidasyonu önlemek için kullanılır. Tel fırça ve SR1 bağlantı bileşiminin kullanılması geçiş direncini azaltır. Ayrıca bağlantıyı korozyondan korur. SL, SM ve KG konnektörler ile alüminyum, çelik ve bakır iletkenler için kullanılır



SKP-SR1



*Bu Ürün Termik Manyetik Şalter Uygulamalarında Kullanılmaktadır.

ALÜMİNYUM & BAKIR SKP - BİMETAL

KOD	KABLO KESİTİ (mm ²)	METRİK (Ø)	ÖLÇÜLER					KUTU ADEDİ	FİYAT / ADET
			D	d	L	L1	B		
SKP-ALCU16	16 mm ²	M8	10	5,5	70,0	32,0	16,0	20	\$1,80
SKP-ALCU25	25 mm ²	M8	12	7,0	75,0	34,0	16,0	20	\$2,10
SKP-ALCU35	35 mm ²	M8	14	8,5	85,0	40,0	20,5	20	\$2,30
SKP-ALCU50	50 mm ²	M8	16	10,0	90,0	42,0	23,0	20	\$2,80
SKP-ALCU70	70 mm ²	M10	18,0	11,5	102,0	47,0	26,0	10	\$3,80
SKP-ALCU95	95 mm ²	M12	21,0	13,5	112,0	50,0	28,0	10	\$4,50
SKP-ALCU120	120 mm ²	M12	23,0	15,0	120,0	53,0	30,0	10	\$6,00
SKP-ALCU150	150 mm ²	M12	25,0	16,5	126,0	55,0	34,0	10	\$6,70
SKP-ALCU185	185 mm ²	M14	27,0	18,5	133,0	58,0	37,0	10	\$8,50
SKP-ALCU240	240 mm ²	M14	30,0	21,0	140,0	60,0	40,0	10	\$11,00
SKP-ALCU300	300 mm ²	M14	34,0	23,5	165,0	65,0	50,0	10	\$18,00
SKP-SR1	Anti Oksidasyon Macunu							1	\$40,00

*SKP-AL mudaili ürünlerde sıkığınız civata veya somun, pul kullansanız dahi sıkılan noktada yumuşak materyalden dolayı kısa bir süre içinde gevşeme yapacaktır.

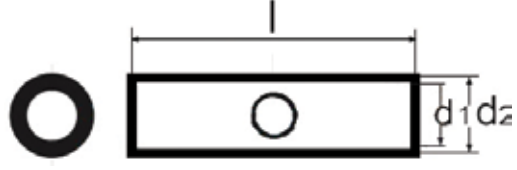

BAKIR TİP EK MUF

KOD	KABLO KESİTİ	d1	d2	KUTU AĞIRLIĞI	RENK	PKT ADEDİ	FİYAT / ADET
STEM006	6 mm	3,8	5,5	25	2,3	800	\$0,45
STEM010	10 mm	4,7	6,6	30	2,5	600	\$0,55
STEM016	16 mm	5,6	7,8	35	2,5	400	\$0,75
STEM025	25 mm	7,1	9,5	40	2,8	250	\$1,27
STEM035	35 mm	8,2	10,8	45	2,3	150	\$1,72
STEM050	50 mm	10,1	13	50	2,3	90	\$2,90
STEM070	70 mm	11,5	14,7	55	2,2	65	\$3,90
STEM095	95 mm	13,5	16,7	60	2,1	50	\$4,10
STEM120	120 mm	15,6	19	65	2,4	40	\$5,60
STEM150	150 mm	16,5	21	70	2,3	25	\$8,60
STEM185	185 mm	18,4	23	75	2,5	22	\$10,40
STEM240	240 mm	21	26	85	2,9	18	\$14,20



W OTOMAT BARALAR / MONOFAZE

KOD	BAKIR KALINLIĞI	BOY	MODÜL	AMPER	PKT ADEDİ	FİYAT / ADET
W-MBR-153	1mm.	53cm.	30 Otomat İçin	80A	100	\$7,50
W-MBR-1106	1mm.	106cm.	56 Otomat İçin	80A	100	\$13,00
W-MBR-1553	1,5mm.	53cm.	30 Otomat İçin	100A	100	\$10,50
W-MBR-15106	1,5mm.	106cm.	56 Otomat İçin	100A	100	\$19,50



W OTOMAT BARALAR / TRİFAZE

KOD	BAKIR KALINLIĞI	BOY	MODÜL	AMPER	PKT ADEDİ	FİYAT / ADET
W-TBR-153	1mm.	53cm.	10 Grup İçin	80A	25	\$18,50
W-TBR-1106	1mm.	106cm.	19 Grup İçin	80A	25	\$36,50
W-TBR-1553	1,5mm.	53cm.	10 Grup İçin	100A	25	\$28,50
W-TBR-15106	1,5mm.	106cm.	19 Grup İçin	100A	25	\$65,00
W-TBR-KAP	TRİFAZE KAPAĞI				100	\$0,25

NOTR TOPRAKLAMA BARALAR

KOD	BAKIR KALINLIĞI	UZUNLUK (mt)	KULLANIM YERİ	PKT ADEDİ	FİYAT / ADET
W-NBR-151531	15mm x 1,5mm	1mt	31 Vida	50	\$17,00
W-NBR-151561	15mm x 1,5mm	1mt	61 Vida	50	\$19,50
W-NBR-152031	15mm x 2mm	1mt	31 Vida	50	\$21,00
W-NBR-152061	15mm x 2mm	1mt	61 Vida	50	\$24,00



İÇİ YAPIŞKANLI DARALAN MAKARONLAR

KOD	ÖLÇÜ (mm)	DARALMADAN ÖNCEKİ Cidar Kalınlığı (mm)	DARALMADAN SONRA (mm)		BOY METRAJİ (mt)	FİYAT
			İç Çap	Yapışkan Katmanı		
TRN-6Y	6,4	1,20±0,10	2	0,45	1,22	\$1,50
TRN-9Y	9,5	1,45±0,10	3	0,50	1,22	\$2,10
TRN-12Y	12,7	1,60±0,20	4,2	0,50	1,22	\$3,50
TRN-16Y	16	1,45±0,20	5,3	0,35	1,22	\$4,20
TRN-19Y	19,1	1,50±0,20	6,3	0,40	1,22	\$5,50
TRN-22Y	22	2,00±0,20	7	0,45	1,22	\$6,00
TRN-25Y	25	2,00±0,20	8	0,45	1,22	\$6,10
TRN-28Y	28	2,00±0,20	9	0,50	1,22	\$6,20
TRN-30Y	30	2,20±0,20	10	0,50	1,22	\$6,40
TRN-33Y	33	2,20±0,20	10	0,50	1,22	\$6,80
TRN-38Y	38	2,70±0,25	12	0,50	1,22	\$7,00
TRN-40Y	40	2,20±0,20	13	0,50	1,22	\$8,00
TRN-44Y	44	2,30±0,25	12,7	0,50	1,22	\$8,90
TRN-52Y	52	2,30±0,25	16	0,50	1,22	\$10,50
TRN-56Y	56	3,00±0,25	16	0,50	1,22	\$11,00
TRN-70Y	70	3,00±0,25	20	0,50	1,22	\$13,00
TRN-75Y	75	3,00±0,25	22	0,50	1,22	\$13,50
TRN-90Y	90	3,70±0,30	27	0,60	1,22	\$18,50
TRN-95Y	95	3,70±0,30	29	0,60	1,22	\$19,50
TRN-115Y	115	3,70±0,35	34	0,60	1,22	\$22,00





Malzeme : Polyoefin
 Daralma Oranı : 2/1
 Çalışma Gerilimi : 600V
 Çalışma Sıcaklığı : -55°C ~125°C
 Halogen Free, Kendi kendine sönmeye özelliği

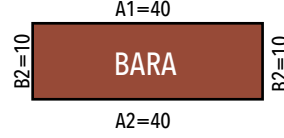

BARAYA UYGUN MAKARON ÇAP HESAPLAMASI

$$\frac{40+40+10+10}{3,14} = 32 \text{ mm} \quad \frac{A1+A2+B1+B2}{3,14} = \varnothing$$



ISI İLE DARALAN MAKARONLAR

*Ürün Kodlarına Başlarken IDM, RD, SYD, KD Olarak Belirtiniz.

KESİT (mm)	DARALMADAN ÖNCEKİ İÇ ÇAP (mm)	DARALMADAN SONRA (mm)		RULO METRAJİ	FİYAT (\$)			
		İç Çap	Et Kalınlığı		(IDM) SİYAH	(RD) ŞEFFAF (RD) BEVAZ (RD) KIRMIZI (RD) MAVİ (RD) YEŞİL (RD) SARIL (RD) GRİ	(SYD) SARI-YEŞİL	(KD) KAHVE
1,6	2,0±0,2	0,85	0,32	200	\$0,13	0,14	0,70	0,17
2,0	2,5±0,2	1,00	0,35	200	\$0,13	0,20	-	-
2,4	3,0±0,3	1,20	0,35	200	\$0,15	0,22	0,50	0,25
2,5	3,0±0,2	1,30	0,38	200	\$0,17	0,25	-	0,30
3,0	3,5±0,2	1,50	0,40	200	\$0,18	-	-	-
3,2	3,5±0,4	1,60	0,40	200	\$0,18	0,26	0,55	0,35
3,5	4,0±0,2	1,80	0,42	200	\$0,20	0,27	-	-
4,0	4,5±0,2	2,00	0,45	200	\$0,23	-	-	-
4,5	5,0±0,2	2,30	0,50	100	\$0,26	-	-	-
4,8	5,3±0,2	2,40	0,53	100	\$0,27	0,32	0,60	0,40
5,0	5,5±0,2	2,50	0,55	100	\$0,29	0,40	-	-
6,0	6,5±0,2	3,00	0,55	100	\$0,32	-	-	-
6,4	7,0±0,2	3,20	0,55	100	\$0,32	0,45	0,65	0,50
7,0	7,5±0,3	3,50	0,55	100	\$0,39	0,48	-	-
8,0	8,5±0,3	4,00	0,60	100	\$0,42	-	-	-
9,5	10,0±0,5	4,80	0,60	100	\$0,44	0,50	0,85	0,55
10,0	10,5±0,3	5,00	0,60	100	\$0,45	-	-	-
12,0	13,2±0,3	6,40	0,65	100	\$0,51	-	-	-
12,7	13,2±0,3	6,40	0,65	100	\$0,51	0,65	1,20	0,75
13,0	13,5±0,3	6,50	0,65	100	\$0,60	0,70	-	0,80
14,0	14,5±0,3	7,00	0,65	100	\$0,70	-	-	-
16,0	16,5±0,4	8,00	0,70	100	\$0,84	1,10	1,75	1,40
18,0	19,0±0,5	9,00	0,80	100	\$1,10	-	-	-
19,1	20,5±0,6	9,50	0,80	100	\$1,15	1,80	2,20	1,80
20,0	21,0±0,5	10,0	0,80	100	\$1,40	1,90	2,30	2,00
22,0	23,0±0,5	11,0	0,80	100	\$1,75	-	-	-
25,0	26,0±0,5	12,5	0,90	50	\$1,90	2,20	3,30	2,40
30,0	31,5±1,0	15,0	0,95	50	\$2,40	-	-	-
32,0	33,0±0,7	15,9	0,95	50	\$2,40	2,90	4,30	3,30
35,0	36,5±1,0	17,5	1,00	50	\$3,00	4,15	5,50	4,90
38,0	40,0±0,7	19,1	1,00	50	\$3,40	4,40	6,00	5,20
40,0	41,5±1,0	20,0	1,00	50	\$3,60	-	-	-
50,0	≥50	25,0	1,00	25	\$4,50	5,00	8,00	5,80
60,0	≥60	31,0	1,30	25	\$5,50	7,00	11,50	9,20
70,0	≥70	34,0	1,30	25	\$7,50	-	-	-
76,0	≥76	36,0	1,30	25	\$8,50	9,20	17,50	11,00
80,0	≥80	41,0	1,46	25	\$9,00	10,00	18,00	12,00

BEYAZ CAM ELYAF MAKARON

ÜRÜN KODU KESİT (mm)	RULO (mt)	FİYAT
NMK-0,8	200	\$0,15
NMK-1,0	200	\$0,15
NMK-1,5	100	\$0,20
NMK-2,0	100	\$0,25
NMK-2,5	100	\$0,28
NMK-3,0	100	\$0,30
NMK-4,0	100	\$0,35
NMK-5,0	100	\$0,55
NMK-6,0	100	\$0,65
NMK-7,0	100	\$0,75
NMK-8,0	100	\$0,85
NMK-10,0	100	\$1,20
NMK-12,0	50	\$1,50
NMK-14,0	50	\$1,80
NMK-16,0	50	\$2,75
NMK-18,0	50	\$2,80
NMK-20,0	25	\$3,75
NMK-25,0	25	\$5,85
NMK-30,0	25	\$6,50
NMK-35,0	25	\$14,50

KIRMIZI H-CLASS CAM ELYAF SİLİKON MAKARON

ÜRÜN KODU KESİT (mm)	RULO (mt)	FİYAT
HMK-1,0	100	\$0,45
HMK-1,5	100	\$0,50
HMK-2,0	100	\$0,55
HMK-2,5	100	\$0,60
HMK-3,0	100	\$0,90
HMK-4,0	100	\$1,10
HMK-5,0	100	\$1,20
HMK-6,0	100	\$1,50
HMK-7,0	100	\$2,00
HMK-8,0	100	\$2,30
HMK-10,0	100	\$2,80
HMK-12,0	50	\$3,40
HMK-14,0	50	\$4,50
HMK-16,0	50	\$5,20
HMK-18,0	50	\$6,20
HMK-20,0	50	\$7,90
HMK-25,0	25	\$13,50
HMK-30,0	25	\$15,00
HMK-35,0	25	\$18,50

NMK



HMK

KABLO TOPLAMA ÇORABI

KOD	ÖZELLİK	MİN. TUTMA ÇAPI (mm)	MAX. TUTMA ÇAPI (mm)	RENK	MAKARA (mt)	FİYAT
KTC-3	Kablo Toplama Çorabı	2,0	6,0	Siyah	100	\$0,32
KTC-4	Kablo Toplama Çorabı	2,2	7,0	Siyah	100	\$0,35
KTC-5	Kablo Toplama Çorabı	2,5	8,0	Siyah	100	\$0,40
KTC-6	Kablo Toplama Çorabı	3,0	9,0	Siyah	100	\$0,45
KTC-8	Kablo Toplama Çorabı	5,0	16,0	Siyah	100	\$0,55
KTC-10	Kablo Toplama Çorabı	7,0	19,0	Siyah	100	\$0,60
KTC-12	Kablo Toplama Çorabı	8,0	24,0	Siyah	100	\$0,75
KTC-15	Kablo Toplama Çorabı	10,0	27,0	Siyah	100	\$0,81
KTC-20	Kablo Toplama Çorabı	14,0	30,0	Siyah	100	\$1,10
KTC-25	Kablo Toplama Çorabı	18,0	35,0	Siyah	50	\$1,35
KTC-30	Kablo Toplama Çorabı	20,0	50,0	Siyah	50	\$1,80
KTC-40	Kablo Toplama Çorabı	30,0	60,0	Siyah	25	\$2,40
KTC-50	Kablo Toplama Çorabı	40,0	80,0	Siyah	25	\$3,15



İZOLE BANT

KOD	ÖZELLİK	PKT ADEDİ	FİYAT / ADET
İZ-19	İzole Bant 19mm x 0,13mm x 10mt	10	\$0,85
İZ-50	İzole Bant 50mm x 0,18mm x 25mt	1	\$7,80
İZ-19 SY	İzole Bant 19mm x 0,13mm x 10mt Sarı/Yeşil	10	\$1,50



ERİYEN BANT

KOD	ÖZELLİK	PKT ADEDİ	FİYAT / ADET
WDX-19	Yarı İletken Bant 19mm x 8mt - 5kV	1	\$4,30
WDX-50	Yarı İletken Bant 50mm x 8mt - 10kV	1	\$9,80



ÇİFT TARAFLI BANT

KOD	ÖZELLİK	PKT ADEDİ	FİYAT / ADET
ÇTB-10	Çift Taraflı Bant 10 mm x 10 mt	1	\$3,80
ÇTB-19	Çift Taraflı Bant 19 mm x 10 mt	1	\$5,80



KABLO BAĞLARI

ÜRÜN KODU	EN-BOY(mm)	RENK	MAX.SIKMA ÇAPI	POŞET ADEDİ	FİYAT / ADET
CT-100 M	2.5 X 100	BEYAZ / SİYAH	24	100	0,013 €
CT-130 M	2.5 X 130	BEYAZ / SİYAH	35	100	0,016 €
CT-160 M	2.5 X 160	BEYAZ / SİYAH	40	100	0,022 €
CT-200 M	2.5 X 200	BEYAZ / SİYAH	55	100	0,026 €
ÜRÜN KODU	EN-BOY(mm)	RENK	MAX.SIKMA ÇAPI	POŞET ADEDİ	FİYAT / ADET
CT-140 I	3.5 X 140	BEYAZ / SİYAH	36	100	0,027 €
CT-200 I	3.5 X 200	BEYAZ / SİYAH	55	100	0,039 €
CT-250 I	3.5 X 250	BEYAZ / SİYAH	68	100	0,049 €
CT-280 I	3.5 X 280	BEYAZ / SİYAH	80	100	0,055 €
CT-370 I	3.5 X 370	BEYAZ / SİYAH	103	100	0,074 €
ÜRÜN KODU	EN-BOY(mm)	RENK	MAX.SIKMA ÇAPI	POŞET ADEDİ	FİYAT / ADET
CT-200 ST	4.5 X 200	BEYAZ / SİYAH	51	100	0,050 €
CT-250 ST	4.5 X 250	BEYAZ / SİYAH	68	100	0,067 €
CT-300 ST	4.5 X 300	BEYAZ / SİYAH	82	100	0,079 €
CT-360 ST	4.5 X 360	BEYAZ / SİYAH	101	100	0,097 €
CT-380 ST	4.5 X 380	BEYAZ / SİYAH	110	100	0,105 €
CT-430 ST	4.5 X 430	BEYAZ / SİYAH	123	100	0,130 €
ÜRÜN KODU	EN-BOY(mm)	RENK	MAX.SIKMA ÇAPI	POŞET ADEDİ	FİYAT / ADET
CT-300 LHD	7.5 X 300	BEYAZ / SİYAH	88	100	0,150 €
CT-370 LHD	7.5 X 370	BEYAZ / SİYAH	101	100	0,192 €
CT-450 LHD	7.5 X 450	BEYAZ / SİYAH	130	100	0,225 €
CT-540 LHD	7.5 X 540	BEYAZ / SİYAH	160	100	0,308 €
CT-750 LHD	7.5 X 750	BEYAZ / SİYAH	220	100	0,429 €
ÜRÜN KODU	EN-BOY(mm)	RENK	MAX.SIKMA ÇAPI	POŞET ADEDİ	FİYAT / ADET
CT-810 HD	9 X 810	BEYAZ / SİYAH	245	100	0,598 €
CT-920 HD	9 X 920	BEYAZ / SİYAH	280	100	0,670 €

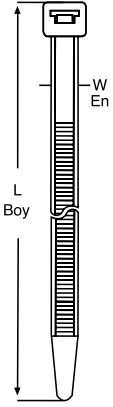

YAPIŞKANLI KABLO BAĞI KROŞESİ

KOD	A	B	C	D	E	POŞET ADEDİ	FİYAT / ADET
W 20A	19	19	3,6	Ø3,2	4,0	100	0,078 €
W 28A	27	27	4,8	Ø3,2	4,5	100	0,143 €



YAPIŞKANLI KABLO BAĞI KROŞESİ

KOD	A	B	C	D	MAX.Bağlama Genişliği	POŞET ADEDİ	FİYAT / ADET
WL-BK	9,5	36,0	6,0	9,5	9,5	250	\$0,07

KABLO BAĞLI ETİKET TAŞIYICI

KOD	EN	BOY	POŞET ADEDİ	KOLİ ADEDİ	FİYAT / ADET
KBET1	19	3,6	4,0	100	\$0,210
KBET2	28	4,8	4,5	100	\$0,320



VİDALI KROŞELER

KOD	A	B	C	D	E	MAX. BAĞLAMA GENİŞLİĞİ	POŞET ADEDİ	FİYAT / ADET
GSM-2	14,9	9,5	6,9	4,5	7,8	4,8	100	\$0,060
GSM-3	22,2	15,9	9,7	6,4	12,6	7,6	100	\$0,080
GSM-5	30,0	15,0	11,7	4,8	-	7,6	100	\$0,110

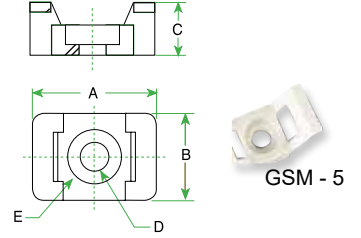

BASKILI DEVRE TAŞIYICI

ÜRÜN KODU	EN-BOY(mm)	POŞET ADEDİ	FİYAT / ADET
CBS-9 A	9,2	1000	\$0,090
CBS-13 A	12,6	1000	\$0,098
CBS-16 A	15,8	1000	\$0,105

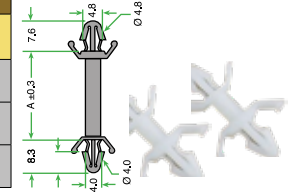

KAPAMA PARÇASI

KOD	ÖLÇÜLER					RENK	ADET	FİYAT / ADET
	A	B	C	D	E			
CE-1	2,60	6,2	7,8	6,0	18,0	Yarı Saydam	1000	\$0,045
CE-2	3,1	7,9	9,5	7,0	20,0		1000	\$0,050
CE-5	4,4	10,5	12,5	9,6	25,5		1000	\$0,080

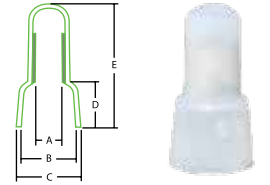

KABLO SIKIŞTIRICISI

KOD	a (mm)	E (mm)	C (mm)	D (mm)	F (mm)	POŞET ADEDİ	FİYAT / ADET
WKS-03	9,6	16,9	4	3,0 (1/8")	1,2	100	\$0,089
WKS-05	9,6	18,5	4	5,3 (3/16")	1,2	100	\$0,098
WKS-06	10,1	20	4	6,8 (1/4")	1,2	100	\$0,078
WKS-08	10	22,6	4	8,4 (5/16")	1,2	100	\$0,086
WKS-10	12,3	26,6	5	10,8 (3/8")	1,4	100	\$0,098
WKS-13	12,2	30,3	5	13,0 (1/2")	1,4	100	\$0,125



HELEZON PANO SİRALİ *50cm

KOD	İÇ ÇAP (mm)	DIŞ ÇAP (mm)	PKT ADEDİ	FİYAT / ADET
HS-1	5	6	100	\$0,12
HS-2	7	8	100	\$0,25
HS-3	10	11	100	\$0,35
HS-4	13	14	50	\$0,75
HS-5	16	17	50	\$0,80



HELEZON PANO SİRALİ *RULO PAKET

KOD	İÇ ÇAP (mm)	DIŞ ÇAP (mm)	PAKET (mt)	FİYAT / PAKET
HS-61	4,1	6,2	10	\$0,31
HS-82	6	8	10	\$0,48
HS-103	7,5	10	10	\$0,78
HS-124	9	12	10	\$1,05
HS-155	12	15	10	\$1,60





METAL KABLO KROŞESİ

KOD	ÖZELLİK	PKT ADEDİ	FİYAT / ADET
WKK-01	Ø7 - Ø16 Sarı Pasivasyon Kaplı Kablo Kroşesi	100	\$3,70
WKK-02	Ø13 - Ø25 Sarı Pasivasyon Kaplı Kablo Kroşesi	100	\$3,85
WKK-03	Ø17 - Ø25 Sarı Pasivasyon Kaplı Kablo Kroşesi	100	\$4,00
WKK-04	Ø22 - Ø28 Sarı Pasivasyon Kaplı Kablo Kroşesi	100	\$4,30
WKK-01HDG	Ø7 - Ø16 Daldırma Galvniiz Kaplı Kablo Kroşesi	100	\$3,80
WKK-02HDG	Ø13 - Ø25 Daldırma Galvniiz Kaplı Kablo Kroşesi	100	\$4,10
WKK-03HDG	Ø17 - Ø25 Daldırma Galvniiz Kaplı Kablo Kroşesi	100	\$4,30
WKK-04HDG	Ø22 - Ø28 Daldırma Galvniiz Kaplı Kablo Kroşesi	100	\$4,60



ALÜMİNYUM KROŞE RAYI

KOD	ÖZELLİK	METRE	FİYAT / ADET
WKKR-01-G	Galvanizli Alüminyum Profil Kroşe Rayı	1m.	\$18,50



PG SOMUNLU POLYAMİD KABLO RAKORU

KOD	BOY (mm)	SIKMA ÇAPI (mm)	PKT ADEDİ	FİYAT / ADET
PKR-7	PG-7	3-7	400	0,33 €
PKR-9	PG-9	4-8	300	0,37 €
PKR-11	PG-11	5-10	200	0,40 €
PKR-13,5	PG-13,5	6-12	150	0,44 €
PKR-16	PG-16	10-14	125	0,51 €
PKR-21	PG-21	13-18	75	0,73 €
PKR-29	PG-29	18-25	30	1,54 €
PKR-36	PG-36	22-32	20	2,44 €
PKR-42	PG-42	30-38	15	2,90 €
PKR-48	PG-48	34-44	8	3,15 €



PG SOMUNLU PİRİNÇ KABLO RAKORU *NİKEL KAPLI

KOD	BOY (mm)	SIKMA ÇAPI (mm)	PKT ADEDİ	FİYAT / ADET
MKR-7	PG-7	3-6,5	50	1,90 €
MKR-9	PG-9	4-8	50	2,21 €
MKR-11	PG-11	5-10	50	2,57 €
MKR-13,5	PG-13,5	6-12	50	3,10 €
MKR-16	PG-16	10-14	25	3,30 €
MKR-21	PG-21	13-18	25	5,00 €
MKR-29	PG-29	18-25	20	9,76 €
MKR-36	PG-36	22-32(33)	15	20,10 €
MKR-42	PG-42	(32)30-38	12	29,90 €
MKR-48	PG-48	34-44	12	38,30 €

YENİ

ARAÇ LİFT KUMANDASI METAL ASMA KORUMA KILIFI



-KIRILMAYA SON-





TOPRAKLAMA KLEMENSLERİ 63A

KOD	ÖZELLİK	PKT ADEDİ	FİYAT / ADET
PTK 06304	4 Delikli 63 Amper Topraklama Klemensi	1000	\$1,00
PTK 06305	5 Delikli 63 Amper Topraklama Klemensi	1000	\$1,20
PTK 06307	7 Delikli 63 Amper Topraklama Klemensi	1000	\$1,50
PTK 06310	10 Delikli 63 Amper Topraklama Klemensi	500	\$2,10
PTK 06312	12 Delikli 63 Amper Topraklama Klemensi	500	\$2,40
PTK 06315	15 Delikli 63 Amper Topraklama Klemensi	250	\$2,90
PTK 06322	22 Delikli 63 Amper Topraklama Klemensi	200	\$4,30



TOPRAKLAMA KLEMENSLERİ 80A

KOD	ÖZELLİK	PKT ADEDİ	FİYAT / ADET
PTK 08004	4 Delikli 80 Amper Topraklama Klemensi	1000	\$1,20
PTK 08005	5 Delikli 80 Amper Topraklama Klemensi	1000	\$1,40
PTK 08007	7 Delikli 80 Amper Topraklama Klemensi	1000	\$1,85
PTK 08010	10 Delikli 80 Amper Topraklama Klemensi	500	\$2,50
PTK 08012	12 Delikli 80 Amper Topraklama Klemensi	500	\$2,75
PTK 08015	15 Delikli 80 Amper Topraklama Klemensi	250	\$3,50
PTK 08022	22 Delikli 80 Amper Topraklama Klemensi	200	\$5,00



TOPRAKLAMA KLEMENSLERİ 125A

KOD	ÖZELLİK	PKT ADEDİ	FİYAT / ADET
PTK 12505	5 Delikli 125 Amper Topraklama Klemensi	250	\$2,60
PTK 12507	7 Delikli 125 Amper Topraklama Klemensi	250	\$3,40
PTK 12510	10 Delikli 125 Amper Topraklama Klemensi	250	\$4,20
PTK 12512	12 Delikli 125 Amper Topraklama Klemensi	250	\$5,25
PTK 12515	15 Delikli 125 Amper Topraklama Klemensi	150	\$6,40
PTK 12522	22 Delikli 125 Amper Topraklama Klemensi	100	\$9,45



1 METRE TOPRAKLAMA KLEMENSLERİ

KOD	ÖZELLİK	PKT ADEDİ	FİYAT / ADET
WL-PTK 080100	1 Metre 80 Amper Topraklama Klemensi	30	\$42,40
WL-PTK 125100	1 Metre 125 Amper Topraklama Klemensi	20	\$60,50



AYAKLI TOPRAKLAMA KLEMENSLERİ 80A

KOD	ÖZELLİK	PKT ADEDİ	FİYAT / ADET
APTK 08007	7 Delikli 80 Amper Ayaklı Topraklama Klemensi	350	\$2,60
APTK 08010	10 Delikli 80 Amper Ayaklı Topraklama Klemensi	350	\$3,20
APTK 08012	12 Delikli 80 Amper Ayaklı Topraklama Klemensi	250	\$3,60
APTK 08015	15 Delikli 80 Amper Ayaklı Topraklama Klemensi	200	\$4,20
APTK 08020	20 Delikli 80 Amper Ayaklı Topraklama Klemensi	200	\$5,20
APTK 08022	22 Delikli 80 Amper Ayaklı Topraklama Klemensi	200	\$5,90

AYAKLI TOPRAKLAMA KLEMENLERİ 125A

KOD	ÖZELLİK	PKT ADEDİ	FİYAT / ADET
APTK 12507	7 Delikli 125 Amper Ayaklı Topraklama Klemensi	125	\$3,90
APTK 12510	10 Delikli 125 Amper Ayaklı Topraklama Klemensi	100	\$5,20
APTK 12512	12 Delikli 125 Amper Ayaklı Topraklama Klemensi	100	\$5,80
APTK 12515	15 Delikli 125 Amper Ayaklı Topraklama Klemensi	75	\$6,80
APTK 12520	20 Delikli 125 Amper Ayaklı Topraklama Klemensi	50	\$9,20
APTK 12522	22 Delikli 125 Amper Ayaklı Topraklama Klemensi	50	\$9,95



2 KUTUPLU DAĞITICI ÜNİTE - 80A (6,5 x 9 mm)

KOD	ÖZELLİK	PKT ADEDİ	FİYAT / ADET
WL-DB 80207	2+5 Delikli 2 Kutuplu Dağıtıcı Ünitesi	30	\$7,50
WL-DB 80210	2+8 Delikli 2 Kutuplu Dağıtıcı Ünitesi	20	\$9,50
WL-DB 80212	2+10 Delikli 2 Kutuplu Dağıtıcı Ünitesi	20	\$10,50
WL-DB 80215	2+13 Delikli 2 Kutuplu Dağıtıcı Ünitesi	20	\$12,00
WL-DB 80220	2+18 Delikli 2 Kutuplu Dağıtıcı Ünitesi	10	\$16,00
WL-DB 80222	2+20 Delikli 2 Kutuplu Dağıtıcı Ünitesi	10	\$18,50



2 KUTUPLU DAĞITICI ÜNİTE - 125A (7 x 12 mm)

KOD	ÖZELLİK	PKT ADEDİ	FİYAT / ADET
WL-DB 125207	2+5 Delikli 2 Kutuplu Dağıtıcı Ünitesi	30	\$9,10
WL-DB 125210	2+8 Delikli 2 Kutuplu Dağıtıcı Ünitesi	20	\$12,20
WL-DB 125212	2+10 Delikli 2 Kutuplu Dağıtıcı Ünitesi	20	\$14,00
WL-DB 125215	2+13 Delikli 2 Kutuplu Dağıtıcı Ünitesi	20	\$16,90
WL-DB 125220	2+18 Delikli 2 Kutuplu Dağıtıcı Ünitesi	10	\$21,50
WL-DB 125222	2+20 Delikli 2 Kutuplu Dağıtıcı Ünitesi	10	\$23,50



4 KUTUPLU DAĞITICI ÜNİTE - 80A (6,5 x 9 mm)

KOD	ÖZELLİK	PKT ADEDİ	FİYAT / ADET
WL-DB 80407	2+5 Delikli 4 Kutuplu Dağıtıcı Ünitesi	15	\$14,00
WL-DB 80410	2+8 Delikli 4 Kutuplu Dağıtıcı Ünitesi	10	\$16,50
WL-DB 80412	2+10 Delikli 4 Kutuplu Dağıtıcı Ünitesi	10	\$19,00
WL-DB 80415	2+13 Delikli 4 Kutuplu Dağıtıcı Ünitesi	10	\$21,50
WL-DB 80420	2+18 Delikli 4 Kutuplu Dağıtıcı Ünitesi	6	\$27,50
WL-DB 80422	2+20 Delikli 4 Kutuplu Dağıtıcı Ünitesi	6	\$30,00



4 KUTUPLU DAĞITICI ÜNİTE - 125A (7 x 12 mm)

KOD	ÖZELLİK	PKT ADEDİ	FİYAT / ADET
WL-DB 125407	2+5 Delikli 4 Kutuplu Dağıtıcı Ünitesi	15	\$16,90
WL-DB 125410	2+8 Delikli 4 Kutuplu Dağıtıcı Ünitesi	10	\$22,50
WL-DB 125412	2+10 Delikli 4 Kutuplu Dağıtıcı Ünitesi	10	\$25,90
WL-DB 125415	2+13 Delikli 4 Kutuplu Dağıtıcı Ünitesi	10	\$31,50
WL-DB 125420	2+18 Delikli 4 Kutuplu Dağıtıcı Ünitesi	6	\$40,50
WL-DB 125422	2+20 Delikli 4 Kutuplu Dağıtıcı Ünitesi	6	\$44,50











TOPRAKLAMA KLEMENS AYAĞI

KOD	ÖZELLİK	PKT ADEDİ	FİYAT / ADET
WL-PA 080	80A Ayak	500	\$0,45
WL-PA 125	125A Ayak	500	\$0,50



ÜRÜN	Ø ÇAP	ÇALIŞMA ŞEKLİ	AKIM	MODEL	FİYAT
	60	İL-X...T6 Serisi			
		Multi	24 VDC	İL-XM-T6-24K	\$40,00
		Multi	220 VAC	İL-XM-T6-22K	\$50,00
		Multi + Buzzer	24 VDC	İL-XMB-T6-24K	\$50,00
		Multi + Buzzer	220 VAC	İL-XMB-T6-22K	\$60,00
		İL-X...R6 Serisi			
		Multi	24 VDC	İL-XM-R6-24K	\$40,00
		Multi	220 VAC	İL-XM-R6-22K	\$50,00
		Multi + Buzzer	24 VDC	İL-XMB-R6-24K	\$50,00
		Multi + Buzzer	220 VAC	İL-XMB-R6-22K	\$60,00
		İL-X...M7 Forklift Serisi			
		Multi	12-80 VDC	İL-XM-F7-80K	\$80,00
		Multi	220 VAC	İL-XM-F7-22K	\$90,00
		Multi + Buzzer	12-80 VDC	İL-XMB-F7-80K	\$90,00
Multi + Buzzer	220 VAC	İL-XMB-F7-22K	\$100,00		
İL-X...T7K Serisi					
Multi	24 VDC	İL-XM-T7K-24K	\$40,00		
Multi	220 VAC	İL-XM-T7K-22K	\$50,00		
Multi + Buzzer	24 VDC	İL-XMB-T7K-24K	\$60,00		
Multi + Buzzer	220 VAC	İL-XMB-T7K-22K	\$70,00		
Not: 7K Serilerinde V-R tipi ürünlerin fiyatları T tipi ile aynıdır.					
	80	İL-X...V8 Serisi			
		Multi	24 VDC	İL-XM-V8-24K	\$80,00
		Multi	220 VAC	İL-XM-V8-22K	\$90,00
		Multi + Buzzer	24 VDC	İL-XMB-V8-24K	\$90,00
		Multi + Buzzer	220 VAC	İL-XMB-V8-22K	\$100,00
		İL-X...T8 Serisi			
		Multi	24 VDC	İL-XM-T8-24K	\$86,00
		Multi	220 VAC	İL-XM-T8-22K	\$96,00
		Multi + Buzzer	24 VDC	İL-XMB-T8-24K	\$96,00
		Multi + Buzzer	220 VAC	İL-XMB-T8-22K	\$106,00
		İL-X...VT8 Serisi			
		Multi	24 VDC	İL-XM-VT8-24K	\$86,00
		Multi	220 VAC	İL-XM-VT8-22K	\$96,00
		Multi + Buzzer	24 VDC	İL-XMB-VT8-24K	\$96,00
Multi + Buzzer	220 VAC	İL-XMB-VT8-22K	\$106,00		
	90	İL-X...T9 Serisi			
		Multi	24 VDC	İL-XM-T9-24K	\$80,00
		Multi	220 VAC	İL-XM-T9-22K	\$90,00
		Multi + Buzzer	24 VDC	İL-XMB-T9-24K	\$90,00
		Multi + Buzzer	220 VAC	İL-XMB-T9-22K	\$100,00
	100	İL-X...T10 Serisi			
		Multi	24 VDC	İL-XM-T10-24K	\$90,00
		Multi	220 VAC	İL-XM-T10-22K	\$100,00
		Multi + Buzzer	24 VDC	İL-XMB-T10-24K	\$100,00
		Multi + Buzzer	220 VAC	İL-XMB-T10-22K	\$110,00
	120	İL-X...T12 Serisi			
		Multi	24 VDC	İL-XM-T12-24K	\$100,00
		Multi	220 VAC	İL-XM-T12-22K	\$110,00
		Multi + Buzzer	24 VDC	İL-XMB-T12-24K	\$110,00
		Multi + Buzzer	220 VAC	İL-XMB-T12-22K	\$120,00

Renk Seçenekleri: 

ÜRÜN	Ø ÇAP	ÇALIŞMA ŞEKLİ	AKIM	MODEL	FİYAT	
 <p>PRO</p> <p>V50</p> <p>V50B</p>	50	İL-X...V50 Serisi				
		Sabit	24 VDC	İL-XSV50-243	Sorunuz	
		Flaşör	24 VDC	İL-XFV50-243	Sorunuz	
		İL-X...V50B Buzzer Serisi				
		Sabit + Buzzer	24 VDC	İL-XSV50B-24	Sorunuz	
		İL-X...T6 Serisi				
	 <p>R6</p> <p>T6</p> <p>QH</p> <p>BH</p> <p>V7K</p> <p>R7K</p> <p>T7K</p>	60	İL-X...T6 Serisi			
			Multi	24 VDC	İL-XM-T6-245	\$50,00
			Multi	220 VAC	İL-XM-T6-225	\$60,00
			Multi + Buzzer	24 VDC	İL-XMB-T6-245	\$60,00
			Multi + Buzzer	220 VAC	İL-XMB-T6-225	\$70,00
			İL-X...R6 Serisi			
 <p>R6</p> <p>T6</p> <p>QH</p> <p>BH</p> <p>V7K</p> <p>R7K</p> <p>T7K</p>		70	İL-X...R6 Serisi			
			Multi	24 VDC	İL-XM-R6-245	\$50,00
			Multi	220 VAC	İL-XM-R6-225	\$60,00
			Multi + Buzzer	24 VDC	İL-XMB-R6-245	\$60,00
			Multi + Buzzer	220 VAC	İL-XMB-R6-225	\$70,00
			İL-X...T7K Serisi			
	 <p>R6</p> <p>T6</p> <p>QH</p> <p>BH</p> <p>V7K</p> <p>R7K</p> <p>T7K</p>	70	İL-X...T7K Serisi			
			Multi	24 VDC	İL-XM-T7K-245	\$50,00
			Multi	220 VAC	İL-XM-T7K-225	\$60,00
			Multi + Buzzer	24 VDC	İL-XMB-T7K-245	\$60,00
			Multi + Buzzer	220 VAC	İL-XMB-T7K-225	\$70,00
			İL-X...R7K Serisi			
 <p>R6</p> <p>T6</p> <p>QH</p> <p>BH</p> <p>V7K</p> <p>R7K</p> <p>T7K</p>		70	İL-X...R7K Serisi			
			Multi	24 VDC	İL-XM-R7K-245	\$50,00
			Multi	220 VAC	İL-XM-R7K-225	\$60,00
			Multi + Buzzer	24 VDC	İL-XMB-R7K-245	\$60,00
			Multi + Buzzer	220 VAC	İL-XMB-R7K-225	\$70,00
			İL-X...V7K Serisi			
	 <p>R6</p> <p>T6</p> <p>QH</p> <p>BH</p> <p>V7K</p> <p>R7K</p> <p>T7K</p>	70	İL-X...V7K Serisi			
			Multi	24 VDC	İL-XM-V7K-245	\$50,00
			Multi	220 VAC	İL-XM-V7K-225	\$60,00
			Multi + Buzzer	24 VDC	İL-XMB-V7K-245	\$60,00
			Multi + Buzzer	220 VAC	İL-XMB-V7K-225	\$70,00
			İL-X...QH Serisi			
 <p>R6</p> <p>T6</p> <p>QH</p> <p>BH</p> <p>V7K</p> <p>R7K</p> <p>T7K</p>		70	İL-X...QH Serisi			
			Multi	24 VDC	İL-XM-QH-X324	\$80,00
			Multi	220 VAC	İL-XM-QH-X322	\$90,00
			Multi + Buzzer	24 VDC	İL-XMB-QH-X324	\$90,00
			Multi + Buzzer	220 VAC	İL-XMB-QH-X322	\$100,00
			İL-X...BH Serisi			
	 <p>R6</p> <p>T6</p> <p>QH</p> <p>BH</p> <p>V7K</p> <p>R7K</p> <p>T7K</p>	70	İL-X...BH Serisi			
			Multi	24 VDC	İL-XM-BH-X324	\$80,00
			Multi	220 VAC	İL-XM-BH-X322	\$90,00
			Multi + Buzzer	24 VDC	İL-XMB-BH-X324	\$90,00
			Multi + Buzzer	220 VAC	İL-XMB-BH-X322	\$100,00



İL-XKT10
\$24,00



İL-XML10
\$28,00



İL-X180
\$16,00



İL-XKL10
\$24,00



İL-X ML
\$16,00



İL-X LA
\$10,00



İL-XBA15S
\$10,00

T5

Ø50



T7

Ø70



Çalışma Şekli	Bes. Gerilimi	Model	Renk	Fiyat	
T5 1 Katlı Işıklı Kolonlar					
Sabit	24 VDC	İL-XS-T5-241	●	\$50,00	
	220 VAC	İL-XS-T5-221		\$60,00	
Sabit + Buzzer	24 VDC	İL-XSB-T5-241		\$82,00	
	220 VAC	İL-XSB-T5-221		\$92,00	
Flaşör	24 VDC	İL-XF-T5-241		\$78,00	
	220 VAC	İL-XF-T5-221		\$84,00	
Flaşör + Buzzer	24 VDC	İL-XFB-T5-241		\$98,00	
	220 VAC	İL-XFB-T5-221		\$108,00	
Çakar	24 VDC	İL-XÇ-T5-241		\$78,00	
	220 VAC	İL-XÇ-T5-221		\$84,00	
Çakar + Buzzer	24 VDC	İL-XÇB-T5-241	\$98,00		
	220 VAC	İL-XÇB-T5-221	\$108,00		
T5 2 Katlı Işıklı Kolonlar					
Sabit	24 VDC	İL-XS-T5-242	●●	\$72,00	
	220 VAC	İL-XS-T5-222		\$76,00	
Sabit + Buzzer	24 VDC	İL-XSB-T5-242		\$94,00	
	220 VAC	İL-XSB-T5-222		\$104,00	
Flaşör	24 VDC	İL-XF-T5-242		\$86,00	
	220 VAC	İL-XF-T5-222		\$102,00	
Flaşör + Buzzer	24 VDC	İL-XFB-T5-242		\$106,00	
	220 VAC	İL-XFB-T5-222		\$116,00	
T5 3 Katlı Işıklı Kolonlar					
Sabit	24 VDC	İL-XS-T5-243		●●●	\$76,00
	220 VAC	İL-XS-T5-223	\$82,00		
Sabit + Buzzer	24 VDC	İL-XSB-T5-243	\$118,00		
	220 VAC	İL-XSB-T5-223	\$128,00		
Flaşör	24 VDC	İL-XF-T5-243	\$98,00		
	220 VAC	İL-XF-T5-223	\$108,00		
Flaşör + Buzzer	24 VDC	İL-XFB-T5-243	\$128,00		
	220 VAC	İL-XFB-T5-223	\$140,00		
T5 4 Katlı Işıklı Kolonlar					
Sabit	24 VDC	İL-XS-T5-244	●●●●		\$86,00
	220 VAC	İL-XS-T5-224		\$102,00	
Sabit + Buzzer	24 VDC	İL-XSB-T5-244		\$132,00	
	220 VAC	İL-XSB-T5-224		\$148,00	
Flaşör	24 VDC	İL-XF-T5-244		\$112,00	
	220 VAC	İL-XF-T5-224		\$126,00	
Flaşör + Buzzer	24 VDC	İL-XFB-T5-244		\$148,00	
	220 VAC	İL-XFB-T5-224		\$164,00	
T5 5 Katlı Işıklı Kolonlar					
Sabit	24 VDC	İL-XS-T5-245		●●●●●	\$94,00
	220 VAC	İL-XS-T5-225	\$110,00		
Sabit + Buzzer	24 VDC	İL-XSB-T5-245	\$144,00		
	220 VAC	İL-XSB-T5-225	\$160,00		
Flaşör	24 VDC	İL-XF-T5-245	\$122,00		
	220 VAC	İL-XF-T5-225	\$160,00		
Flaşör + Buzzer	24 VDC	İL-XFB-T5-245	\$164,00		
	220 VAC	İL-XFB-T5-225	\$184,00		

Çalışma Şekli	Bes. Gerilimi	Model	Renk	Fiyat	
T7 1 Katlı Işıklı Kolonlar					
Multi	24 VDC	İL-XM-T7-241	●	\$40,00	
	220 VAC	İL-XM-T7-221		\$50,00	
Multi + Buzzer	24 VDC	İL-XMB-T7-241		\$60,00	
	220 VAC	İL-XMB-T7-221		\$70,00	
T7 2 Katlı Işıklı Kolonlar					
Multi	24 VDC	İL-XM-T7-242		●●	\$60,00
	220 VAC	İL-XM-T7-222	\$70,00		
Multi + Buzzer	24 VDC	İL-XMB-T7-242	\$80,00		
	220 VAC	İL-XMB-T7-222	\$90,00		
T7 3 Katlı Işıklı Kolonlar					
Multi	24 VDC	İL-XM-T7-243	●●●		\$70,00
	220 VAC	İL-XM-T7-223		\$80,00	
Multi + Buzzer	24 VDC	İL-XMB-T7-243		\$90,00	
	220 VAC	İL-XMB-T7-223		\$100,00	
T7 4 Katlı Işıklı Kolonlar					
Multi	24 VDC	İL-XM-T7-244		●●●●	\$80,00
	220 VAC	İL-XM-T7-224	\$90,00		
Multi + Buzzer	24 VDC	İL-XMB-T7-244	\$100,00		
	220 VAC	İL-XMB-T7-224	\$110,00		
T7 5 Katlı Işıklı Kolonlar					
Multi	24 VDC	İL-XM-T7-245	●●●●●		\$90,00
	220 VAC	İL-XM-T7-225		\$100,00	
Multi + Buzzer	24 VDC	İL-XMB-T7-245		\$110,00	
	220 VAC	İL-XMB-T7-225		\$120,00	

* Multi ürünlerimiz Sabit, Flaşör, Döner, Çakar özellikler ile sipariş edilebilir.

M70 Modüler

İL-XM70
Buzzer

İL-XM70
Led Lens

İL-XM70
Gövde



MB-BH..1

MB-BH..2

MB-BH..3

MB-QH

B-QH

B-BH

Çalışma Şekli	Bes. Gerilimi	Model	Renk	Fiyat
İL-X..67 Serisi Modüler İkaz Lambaları				
Multi	24 VDC	İL-XM67M-24		\$74,00
	220 VAC	İL-XM67M-22		\$90,00
Buzzer	24 VDC	İL-XM67B-24		\$58,00
	220 VAC	İL-XM67B-22		\$68,00
İL-XT67 Gövde		İL-XT67-G		\$46,00
Renk seçenekleri: * İL-XM67M-24K / 24S / 24Y / 24M / 24B				

Çalışma Şekli	Bes. Gerilimi	Model	Renk	Fiyat
İL-X..-B-Q Serisi 105dB 1 Katlı Borulu Kornalar				
Multi	24 VDC	İL-XMB-QH-24K		\$80,00
	220 VAC	İL-XMB-QH-22K		\$90,00
	24 VDC	İL-XMB-BH-24K		\$80,00
	220 VAC	İL-XMB-BH-22K		\$90,00
İL-X..-B-Q Serisi 105dB 2 Katlı Borulu Kornalar				
Multi	24 VDC	İL-XMB-QH-242		\$120,00
	220 VAC	İL-XMB-QH-222		\$140,00
	24 VDC	İL-XMB-BH-242		\$120,00
	220 VAC	İL-XMB-BH-222		\$140,00
İL-X..-B-Q Serisi 105dB 3 Katlı Borulu Kornalar				
Multi	24 VDC	İL-XMB-QH-243		\$140,00
	220 VAC	İL-XMB-QH-223		\$160,00
	24 VDC	İL-XMB-BH-243		\$140,00
	220 VAC	İL-XMB-BH-223		\$160,00
İL-X..-B-Q Serisi 105dB 4 Katlı Borulu Kornalar				
Multi	24 VDC	İL-XMB-QH-244		\$160,00
	220 VAC	İL-XMB-QH-224		\$180,00
	24 VDC	İL-XMB-BH-244		\$160,00
	220 VAC	İL-XMB-BH-224		\$180,00
İL-X..-B-Q Serisi 105dB 5 Katlı Borulu Kornalar				
Multi	24 VDC	İL-XMB-QH-245		\$180,00
	220 VAC	İL-XMB-QH-225		\$200,00
	24 VDC	İL-XMB-BH-245		\$180,00
	220 VAC	İL-XMB-BH-225		\$200,00

BUZZER SERİSİ	Bes. Gerilimi	Model	Bağlantı Tipi	Fiyat
İL-XB-Q Serisi	24V	İL-XB-Q-24	Kablo / Konnektör	\$52,00
	220V	İL-XB-Q-22	Kablo / Konnektör	\$52,00
İL-XB-QH Serisi	24V	İL-XB-QH-24	Kablo / Konnektör	\$62,00
	220V	İL-XB-QH-22	Kablo / Konnektör	\$62,00
İL-XB-B Serisi	24V	İL-XB-B-24	Kablo / Konnektör	\$52,00
	220V	İL-XB-B-22	Kablo / Konnektör	\$52,00
İL-XB-BH Serisi	24V	İL-XB-BH-24	Kablo / Konnektör	\$62,00
	220V	İL-XB-BH-22	Kablo / Konnektör	\$62,00

Sürüklenebilir dip siviç ile 4 farklı modda çalışma

8 Farklı Ses Melodisi

Teknolojisi ile 4 farklı Modda Çalışma

0...127 dB Potansiyometre ile Ayarlanabilir Ses Seviyesi





İLX PRO SERİSİ ALÜMİNYUM/METAL GÖVDELİ İŞIKLI KOLONLAR

İLXPROB-241	İLXPROB-241B	İLXPROB-242	İLXPROB-242B	İLXPROB-243	İLXPROB-243B	İLXPROB-244	İLXPROB-244B	İLXPROB-245	İLXPROB-245B
Sabit	Sabit + Buzzer	Sabit	Sabit + Buzzer	Sabit	Sabit + Buzzer	Sabit	Sabit + Buzzer	Sabit	Sabit + Buzzer
1 Kat	1 Kat	2 Kat	2 Kat	3 Kat	3 Kat	4 Kat	4 Kat	5 Kat	5 Kat
24 VDC	24 VDC	24 VDC	24 VDC	24 VDC	24 VDC	24 VDC	24 VDC	24 VDC	24 VDC
●	●	●●	●●	●●●	●●●	●●●●	●●●●	●●●●●	●●●●●
\$165,60	\$186,40	\$186,40	\$207,00	\$207,10	\$227,80	\$227,80	\$248,50	\$248,50	\$269,20\$



İLX PRO SERİSİ ALÜMİNYUM/METAL GÖVDELİ IŞIKLI KOLONLAR

İLXPRO-241	İLXPRO-241B	İLXPRO-242	İLXPRO-242B	İLXPRO-243	İLXPRO-243B	İLXPRO-244	İLXPRO-244B	İLXPRO-245	İLXPRO-245B
Sabit	Sabit + Buzzer	Sabit	Sabit + Buzzer	Sabit	Sabit + Buzzer	Sabit	Sabit + Buzzer	Sabit	Sabit + Buzzer
1 Kat	1 Kat	2 Kat	2 Kat	3 Kat	3 Kat	4 Kat	4 Kat	5 Kat	5 Kat
24 VDC	24 VDC	24 VDC	24 VDC	24 VDC	24 VDC	24 VDC	24 VDC	24 VDC	24 VDC
●	●	●●	●●	●●●	●●●	●●●●	●●●●	●●●●●	●●●●●
\$165,70	\$186,40	\$186,40	\$207,00	\$207,10	\$227,80	\$227,80	\$248,50	\$248,50	\$269,20

Termal baskı, amteryal polyester, endüstriyel kullanım için özel dayanıklı dış yüzey, yırtılmaz, ışıktan etkilenmez.

"KAĞIT DEĞİLDİR"

YAPIŞKANLI UYARI ETİKETLERİ

Min.Adet: 50

Fiyat: \$0,50 / Adet

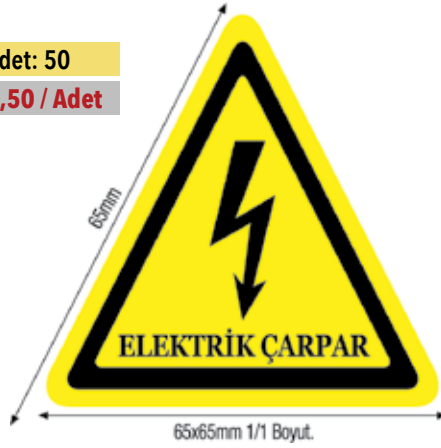

Min.Adet: 50

Fiyat: \$0,75 / Adet



Min.Adet: 50

Fiyat: \$0,75 / Adet

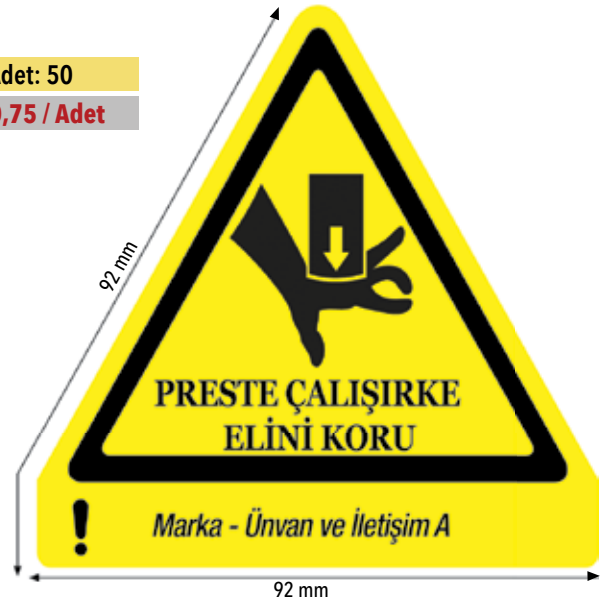

G1



G2



G3



G4



G5



G6



G7



G8



G9



G10



G11



G12



G13



G14



G15



G16



G17



G18



G19



G20



G21



G22



G23



G24



25



G26



G27

"İŞRAET DİLİ ORTAK DİLDİR" Siparişleriniz için G... -65 olarak belirtiniz. Örnek: G7 - 65 / G8 - 92

Termal baskı, amteryal polyester, endüstriyel kullanım için özel dayanıklı dış yüzey, yırtılmaz, ışıktan etkilenmez.

"KAĞIT DEĞİLDİR"

YAPIŞKANLI KUTULU ACİL STOP ETİKETLERİ



LAY5-ER60ET

Min.Adet : 100

Fiyat: \$0,40 / Adet



LAY5-ER60E

Min.Adet : 100

Fiyat: \$0,40 / Adet



LAY5-ER60ET-1

Min.Adet : 100

Fiyat: \$0,40 / Adet



Min.Adet : 100

Fiyat: \$0,40 / Adet

METAL ÖLÜM TEHLİKE LEVHASI



Min.Adet : 20

Fiyat: \$2,20 / Adet

"İŞRAET DİLİ ORTAK DİLDİR" Siparişleriniz için G... -65 olarak belirtiniz. Örnek: G7 - 65 / G8 - 92

YAPIŞKANLI UYARI ETİKETLERİ

Min.Adet :20

Fiyat: \$0,90 / Adet

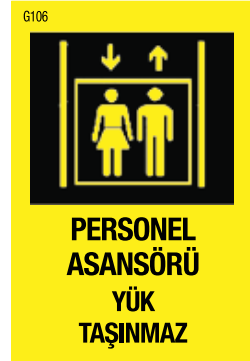

Leksan baskılı olup, Kimyasal Maddelerden zarar görmez.

"YAPIŞKANDIR"

ÖLÜM TEHLİKE LEVHALARI





MULTİMETRE	
KOD	DT-830
FİYAT	\$27,50
DC Voltaj	500V
AC Voltaj	500V
DC Akım	5A
Direnç	200 Ω - 2 M Ω
Test	Diyot - Transistör
Ekran	16 x 48 mm
Ebat	125 x 70 x 25 mm



MULTİMETRE - BUZZERLİ	
KOD	DT-830D
FİYAT	\$30,00
DC Voltaj	500V
AC Voltaj	500V
DC Akım	5A
Direnç	200 Ω - 2 M Ω
Test	Diyot - Transistör
Ekran	16 x 48 mm
Ebat	125 x 70 x 25 mm



PENSAMPERMETRE	
KOD	CM-266
FİYAT	\$35,00
DC Voltaj	1000V
AC Voltaj	750V
AC Akım	1000A
Direnç	200 Ω - 2 M Ω
Buzzer	Var
Ekran	14 x 47 mm
Ebat	230 x 70 x 37 mm



PENSAMPERMETRE	
KOD	CM-266FT
FİYAT	\$40,00
DC Voltaj	1000V
AC Voltaj	750V
AC Akım	1000A
Direnç	200 Ω - 2 M Ω
Sıcaklık	-20°C - 750°C
Frekans	10Hz - 10MHz
Buzzer	Var
Ekran	14 x 47 mm
Ebat	230 x 70 x 37 mm



MULTİMETRE - BUZZERLİ	
KOD	MAS-830L
FİYAT	\$35,00
DC Voltaj	600V
AC Voltaj	600V
DC Akım	10A
Direnç	200 Ω - 2 M Ω
Test	Diyot - Transistör
Ekran	38 x 48 mm
Ebat	200 x 95 x 45 mm



NETWORK KABLO TEST CİHAZI	
KOD	MC-55
FİYAT	\$24,00
Ölçüm Yeri	RJ-45, RJ-11
Pil	9V

DİJİTAL PENS AMPERMETRELER



UT-200A		UT-201+		UT-202+	
FİYATI : \$67,00		FİYATI : \$85,00		FİYATI : \$97,00	
Teknik Özellikler	Aralık	Teknik Özellikler	Aralık	Teknik Özellikler	Aralık
AC akımı (A)	2A / 20A / 200A	AC akımı (A)	400A	AC akımı (A)	400A
AC voltajı (V)	600V	AC akım frekansı (Hz)	50 Hz ~ 100 Hz	AC akım frekansı (Hz)	50 Hz ~ 100 Hz
DC voltajı (V)	600V	AC voltajı (V)	600V	AC voltajı (V)	600V
Direnç (Ω)	20kΩ	AC voltaj frekansı (Hz)	10 Hz ~ 10 kHz	AC voltaj frekansı (Hz)	10 Hz ~ 10 kHz
		DC voltajı (A)	600V	DC voltajı (A)	600V
		Direnç (Ω)	40 milyon	Direnç (Ω)	40 milyon
				Kapasite (F)	4mF
				Sıcaklık (°C)	-40 °C ~ 1000 °C



UT-202A+		UT-203+		UT-204+	
FİYATI : \$89,00		FİYATI : \$172,50		FİYATI : \$191,00	
Teknik Özellikler	Aralık	Teknik Özellikler	Aralık	Teknik Özellikler	Aralık
AC akımı (A)	600A	AC akımı (A)	400A	AC akımı (A)	600A
AC akım frekansı (Hz)	50 Hz ~ 100 Hz	DC akımı (A)	400A	DC akımı (A)	600A
AC voltajı (V)	600V	AC voltajı (V)	600V	AC voltajı (V)	600V
AC voltaj frekansı (Hz)	10 Hz ~ 10 kHz	AC voltaj frekansı (Hz)	10 Hz ~ 60 kHz	AC voltaj frekansı (Hz)	10 Hz ~ 60 kHz
DC voltajı (A)	600V	DC voltajı (A)	600V	DC voltajı (A)	600V
Direnç (Ω)	60 milyon	Direnç (Ω)	40 milyon	Direnç (Ω)	60 milyon
Kapasite (F)	60mF	Kapasite (F)	40mF	Kapasite (F)	60mF
Frekans (Hz)	10 Hz ~ 10 MHz	Frekans (Hz)	10 Hz ~ 10 MHz	Sıcaklık (°C)	-40 °C ~ 1000 °C
				Frekans (Hz)	10 Hz ~ 10 MHz

DİJİTAL PENS AMPERMETRELER



UT-206B		UT-208B		UT-210E	
FİYATI : \$250,00		FİYATI : \$377,00		FİYATI : \$202,50	
Teknik Özellikler	Aralık	Teknik Özellikler	Aralık	Teknik Özellikler	Aralık
AC akımı (A)	1000A	AC akımı (A)	1000A	AC akımı (A)	100A
Ani akım (A)	1000A	DC akımı (A)	1000A	DC akımı (A)	100A
AC voltajı (V)	6V 60V / 600V / 1000V	Ani akım (A)	1000A	AC voltajı (V)	600V
DC voltajı (V)	600mV 6V / 60V 600V 1000V	AC voltajı (V)	6V 60V / 600V / 1000V	DC voltajı (V)	600V
Düşük pas İtler (LPF ACV)	600V / 1000V	DC voltajı (V)	600mV 6V / 60V 600V 1000V	Direnç (Ω)	20 milyon
LoZ ACV	600V / 1000V	Düşük pas İtre (LPF ACV)	600V / 1000V	Kapasite (F)	20mF
Direnç (Ω)	600Ω 6KΩ / 60KΩ / 600KΩ	LoZ ACV	600V / 1000V	Kapasite (F)	60nF 600nF / 6μF / 60μF / 600μF
	6 milyon / 60 milyon	Direnç (Ω)	600Ω 6KΩ / 60KΩ / 600KΩ 6 milyon / 60 milyon		
Kapasite (F)	60nF 600nF / 6μF / 60μF / 600μF	Sıcaklık (?)	-40 ? ~ 300 / 300 ~ 1000 ?	Düşük voltaj frekansı (Hz)	10 Hz ~ 1 MHz
	6mF / 60mF				
Sıcaklık (°C)	-40 °C ~ 300 300 ~ 1000 °C	Görev döngüsü (%)	% 10 ~ % 90		
Düşük voltaj frekansı (Hz)	10 Hz ~ 1 MHz				
Görev döngüsü (%)	% 10 ~ % 90				



UT-219E		UT-219DS		UT-221 (TRUE RMS)		UT-222 (TRUE RMS)	
FİYATI : \$333,50		FİYATI : \$501,50		FİYATI : \$662,50		FİYATI : \$753,00	
Teknik Özellikler	Aralık	Teknik Özellikler	Aralık	Teknik Özellikler	Aralık	Teknik Özellikler	Aralık
AC akımı (A)	600A	AC akımı (A)	600A	AC akımı (A)	2000A	AC akımı (A)	2500A
AC voltajı (V)	600V	DC akımı (A)	600A	DC akımı (A)	2000A	DC akımı (A)	2500A
DC voltajı (V)	600V	AC voltajı (V)	600V	AC voltajı (V)	750V	AC voltajı (V)	1000V
LoZ ACV	600V	DC voltajı (V)	600V	DC voltajı (V)	1000V	DC voltajı (V)	1000V
Direnç (Ω)	60 milyon	LoZ ACV	600V	Direnç (Ω)	60 milyon	Direnç (Ω)	60 milyon
Kapasite (F)	60mF	Direnç (Ω)	60 milyon	Frekans (Hz)	20 MHz	Kapasite (F)	60mF
Frekans (Hz)	10 Hz ~ 10 MHz	Kapasite (F)	60mF	Görev döngüsü (%)	% 0.1 ~ % 99.9	Frekans (Hz)	60 MHz
Görev döngüsü	% 0.1 ~ % 99.9	Frekans (Hz)	600Hz ~ 40MHz			Sıcaklık	-40 °C ~ 1000 °C / -40 °F ~ 1832 °F
		Görev döngüsü	% 0.1 ~ % 99.9				
		Sıcaklık	-40 ~ 1000 °C / -40 ~ 1832 °F				

AVUÇ İÇİ DİJİTAL MULTİMETRELER

AVUÇ İÇİ DİJİTAL MULTİMETRELER



UT-33A+		UT-33B+		UT-33C+		UT-33D+	
FİYATI : \$60,50		FİYATI : \$39,80		FİYATI : \$48,50		FİYATI : \$41,00	
Teknik Özellikler	Aralık	Teknik Özellikler	Aralık	Teknik Özellikler	Aralık	Teknik Özellikler	Aralık
DC voltajı (V)	200mV / 2V / 20V / 200V / 600V	DC voltajı (V)	200mV / 2V / 20V / 200V / 600V	DC voltajı (V)	200mV / 2V / 20V / 200V / 600V	DC voltajı (V)	200mV / 2V / 20V / 200V / 600V
AC voltajı (V)	600V	AC voltajı (V)	200V / 600V	AC voltajı (V)	200V / 600V	AC voltajı (V)	200V / 600V
DC akımı (A)	10:00 00	DC akımı (A)	200µA / 200mA / 10A	DC akımı (A)	2000µA / 20mA / 200mA / 10A	DC akımı (A)	2000µA / 20mA / 200mA / 10A
AC akımı (A)	10:00 00	Direnç (Ω)	200Ω / 2kΩ / 20kΩ	Direnç (Ω)	200Ω / 2kΩ / 20kΩ / 200kΩ / 20MΩ	Direnç (Ω)	200Ω / 2kΩ / 20kΩ
Direnç (Ω)	200Ω / 2kΩ / 20kΩ / 200kΩ		/ 200kΩ / 20MΩ		Sıcaklık		-40 °C ~ 1000 °C / 40 °F ~ 1832 °F
Kapasite (F)	2mF	Kapasite (F)	60mF	Frekans (Hz)	10 Hz ~ 10 MHz	Görev döngüsü	% 0.1 ~ % 99.9

GENEL AMAÇLI DİJİTAL MULTİMETRELER

CEP TİPİ DİJİTAL MULTİMETRELER



UT-39A+		UT-39C+		UT-120A		UT-120C	
FİYATI : \$64,50		FİYATI : \$71,50		FİYATI : \$59,80		FİYATI : \$75,90	
Teknik Özellikler	Aralık	Teknik Özellikler	Aralık	Teknik Özellikler	Aralık	Teknik Özellikler	Aralık
DC voltajı (V)	400mV / 4V / 40V / 400V / 1000V	DC voltajı (V)	400mV / 4V / 40V / 400V / 1000V	DC voltajı (V)	600V	DC voltajı (V)	600V
AC voltajı (V)	4V / 40V / 400V / 750V	AC voltajı (V)	4V / 40V / 400V / 750V	AC voltajı (V)	600V	AC voltajı (V)	600V
DC akımı (A)	40uA / 400uA / 4mA / 40mA / 400mA / 10A	DC akımı (A)	400uA / 400mA / 10A	Direnç (Ω)	40 milyon	DC akımı (A)	400mA
AC akımı (A)	40mA / 400mA / 10A	AC akımı (A)	4mA / 400mA / 10A	Frekans (Hz)	100 kHz	AC akımı (A)	400mA
Direnç (Ω)	400Ω / 4000Ω / 40kΩ / 400kΩ / 4MΩ / 200MΩ	Direnç (Ω)	400Ω / 4000Ω / 40kΩ / 400kΩ / 4MΩ / 40MΩ	Direnç (Ω)	40 milyon	Direnç (Ω)	40 milyon
Kapasite (F)	4nF / 40nF / 400nF / 4uF / 40uF / 400uF / 4mF / 10mF		Kapasite (F)	4nF / 40nF / 400nF / 4uF / 40uF / 400uF / 4mF / 10mF	Kapasite (F)	100µF	Kapasite (F)
		Frekans (Hz)	10 Hz ~ 1 MHz	Frekans (Hz)	100 kHz	Frekans (Hz)	100 kHz

GENEL AMAÇLI DİJİTAL MULTİMETRELER

GENEL AMAÇLI DİJİTAL MULTİMETRELER

TRUE RMS KAYITLI DİJİTAL MULTİMETRELER



UT-58A		UT-58C		UT-58E		UT-139C	
FİYATI : \$110,00		FİYATI : \$131,00		FİYATI : \$230,00		FİYATI : \$167,50	
Teknik Özellikler	Aralık	Teknik Özellikler	Aralık	Teknik Özellikler	Aralık	Teknik Özellikler	Aralık
DC voltajı (V)	200mV / 2V / 20V / 200V / 1000V	DC voltajı (V)	200mV / 2V / 20V / 200V / 1000V	DC voltajı (V)	200mV / 2V / 20V / 200V / 1000V	DC voltajı (V)	600V
AC voltajı (V)	2V / 20V / 200V / 750V	AC voltajı (V)	2V / 20V / 200V / 750V	AC voltajı (V)	2V / 20V / 200V / 1000V	AC voltajı (V)	600V
DC akımı (A)	20µA / 2mA / 20mA / 200mA / 20A	DC akımı (A)	2mA / 200mA / 20A	DC akımı (A)	2mA / 200mA / 20A	DC akımı (A)	10:00 ÖÖ
AC akımı (A)	2mA / 200mA / 20A	AC akımı (A)	2mA / 200mA / 20A	AC akımı (A)	20mA / 200mA / 20A	AC akımı (A)	10:00 ÖÖ
Direnç (Ω)	200Ω / 2kΩ / 20kΩ / 2MΩ / 20MΩ / 200MΩ	Direnç (Ω)	200Ω / 2kΩ / 20kΩ / 2MΩ / 20MΩ	Direnç (Ω)	200Ω / 2kΩ / 20kΩ / 2MΩ / 200MΩ	Direnç (Ω)	60 milyon
Kapasite (F)	2nF / 200nF / 100µF	Kapasite (F)	2nF / 200nF / 100µF	Kapasite (F)	2nF / 20nF / 2µF / 20µF	Kapasite (F)	99,99 mF
		Frekans (Hz)	2 kHz / 20 kHz	Frekans (Hz)	20 kHz	Frekans (Hz)	10 Hz ~ 10 MHz
		Sıcaklık (° C)	-40 ° C ~ 1000 ° C	Sıcaklık (° C)	-40 ° C ~ 1000 ° C	Sıcaklık (° C)	-40 ° C ~ 1000 ° C
						Sıcaklık (° F)	-40 ° F ~ 1832 ° F

OSİLOSKOP TİPİ DİJİTAL MULTİMETRELER

KALEM TİPİ DİJİTAL MULTİMETRELER



UT-81B		UT-118B	
FİYATI : \$874,00		FİYATI : \$106,00	
Teknik Özellikler	Aralık	Teknik Özellikler	Aralık
DC voltajı (V)	1000V	Teknik Özellikler	Aralık
AC voltajı (V)	750V		(TARAMA Modu)
DC akımı (A)	10:00 ÖÖ	DC voltajı (V)	300V
AC akımı (A)	10:00 ÖÖ	AC Genilimi (V)	300V
Direnç (Ω)	40 milyon	Direnç (Ω)	3 milyon
Kapasite (F)	100µF	Kapasite (F)	300µF
Frekans (Hz)	10 Hz ~ 10 MHz		
Bant genişliği	8 MHz		
Örnekleme oranı	40 MS / sn		
Dikey doğruluk	± (% 5 + 1)		
Dikey hassasiyet	√		
Zaman bazlı doğruluk	± (% 0,01 + 1)		
Zaman tabanı aralığı	100ns / div -5s / böl (1-2-5)		

INFRARED LAZERLİ TERMOMETRE



UT-300A+		UT-300S		UT-302C+		UT-303C+	
FİYATI : \$53,00		FİYATI : \$67,00		FİYATI : \$250,00		FİYATI : \$402,50	
Teknik Özellikler	Aralık	Teknik Özellikler	Aralık	Teknik Özellikler	Aralık	Teknik Özellikler	Aralık
Sıcaklık aralığı	-20 °C ~ 400 °C -4 °F ~ 752 °F	Sıcaklık aralığı	-32 °C ile 400 °C -25.6 °F ile 752 °F	Sıcaklık aralığı	-32°C ~ 110000 -25.6 °F ~ 2012 °F	Sıcaklık aralığı	-32 °C ~ 1300 °C -25.6°F ~ 2372°F
Doğruluk	> 0 °C: ± 2.0 °C veya ±% 2; <0 °C: ± (2,0 + 0,1 °C / °C)	Doğruluk	± 2 °C veya ±% 2	Doğruluk	≥0 °C: ± 1.5 °C veya ±% 1.5; <0 °C: ± (1,5 + 0,1 °C / °C)	Doğruluk	≥0 °C: ± 1.5 °C veya ±% 1.5; <0 °C: ± (1,5 + 0,1 °C / °C)
	> 32 °F: ± 4.0 °F veya ±% 2; <32 °F: ± (4,0 + 0,1 °F / °F)	Tekrarlanabilirlik	± 0,5 °C veya ±% 0,5		> 32 °F: ± 3.0 °F veya ±% 1.5; <32 °F: ± (3,0 + 0,1 °F / °F)		Tekrarlanabilirlik
Tekrarlanabilirlik	1 °C veya% 1.0 (2 °F veya% 1.0)	Spot Boyutuna Uzaklık	12:01	Tekrarlanabilirlik	0.7 °C veya% 0.7 (1.5 °F veya% 0.7)	Tekrarlanabilirlik	0.7 °C veya% 0.7 (1.5 °F veya% 0.7)
D: S oranı	10:01	Tepki Süresi	500 ms	D: S oranı	20:01	D: S oranı	30:01:00
Tepki Süresi	≤500ms (okumanın% 95'i)	Emisivite	0.10 ~ 1.00 Ayarlanabilir	Tepki Süresi	250 ms	Tepki Süresi	250 ms
Emisivite	0.95	Lazer Tipi	Sınıf 2	Emisivite	0.1 ~ 1.0 (ayarlanabilir, 5 set önceden ayarlanmış değer depolar)	Emisivite	0.1 ~ 1.0 (ayarlanabilir, 5 set önceden ayarlanmış değer depolar)
Spektral cevap	5.5um ~ 14um	Lazer Gücü	1mW	Spektral cevap	8um ~ 14um	Spektral cevap	8um ~ 14um
Lazer gücü	<1mW	Lazer Dalga Boyu	630 nm 670 nm	Lazer gücü	<1mW	Lazer gücü	<1mW
		Spektral cevap	8µm 14µm				

INFRARED KIZILÖTESİ TERMOMETRE

PROFESYONEL INFRARED LAZERLİ TERMOMETRE

TİTREŞİM VE VİBRASYON TEST CİHAZI



UT-306A		UT-309A		UT-315A	
FİYATI : \$71,50		FİYATI : \$209,50		FİYATI : 1.380,00 \$	
Teknik Özellikler	Aralık	Teknik Özellikler	Aralık	Teknik Özellikler	Aralık
Sıcaklık aralığı	-35 °C ~ 300 -31 °F ~ 572 °F	Sıcaklık aralığı	-35 °C ile 450 °C -31 °F ~ 842 °F	Hızlanma (OP)	0 ~ 199.9m / s²; Frekans tepkisi: 10Hz-10kHz Doğruluk: ± (% 5 + 0.2m / s²)
Doğruluk	≥0 °C: ± 2.0 °C veya ±% 2; <0 °C: ± (2,0 °C + 0,1 °C / °C)	Doğruluk	≥0 °C: ± 1.8 °C veya ± 1.8%	Hız (RMS)	0 ~ 19.99cm / s; Frekans tepkisi: 10Hz ~ 1kHz Doğruluk: ± (% 5 + 0.02cm / s)
	≥32 °F: ± 4.0 °F veya ±% 2; <32 °F: ± (4.0 °F + 0.1 °F / °F)		<0 °C: ± (1,8 °C + 0,1 °C / °C)	Deplasman (PP)	1 ~ 1,999 mm; Frekans tepkisi: 10 Hz ~ 500 Hz Doğruluk: ± (% 5 + 0,002 mm)
D: S oranı	06:01	Çözüm	0.1 °C / 0.1 °F		
Tepki Süresi	<250 ms	D: S oranı	10:01		
Emisivite	0.95	Tepki Süresi	250 ms (okumanın% 95'i)		
Spektral cevap	8um ~ 14um	Emisivite	22:48		
Lazer gücü	<1mW	Lazer sayısı	Tek lazer		
		Lazer türü	Sınıf 2		
		Lazer gücü	<1mW		
		Lazer dalga boyu	630 nm ~ 670 nm		

MİNİ SICAKLIK VE NEM ÖLÇER



MİNİ DESİBELMETRE



MİNİ ANEMOMETRE



UT-333		UT-333BT		UT-353BT		UT-363BT	
FİYATI : \$71,50		FİYATI : \$85,50		FİYATI : \$89,70		FİYATI : \$85,50	
Teknik Özellikler	Aralık	Teknik Özellikler	Aralık	Teknik Özellikler	Aralık	Teknik Özellikler	Aralık
Sıcaklık	-10 °C ~ 60 14 °F ~ 140	Sıcaklık	-10 °C ~ 60 14 °F ~ 140	Gürültü (Ağırlıklandırma)	30 ~ 130 dB	Rüzgar hızı	0 ~ 30 m / sn
Sıcaklık doğruluğu	± 1.0 °C / ± 2.0 °F	Sıcaklık doğruluğu	± 1.0 °C / ± 2.0 °F	Doğruluk çözüm	± 1.5dB 0.1dB	Rüzgar hızı doğruluğu	± (değerin% 5'i + 0.5)
Sıcaklık çözünürlüğü	0.1 / 0.2°F	Sıcaklık çözünürlüğü	0.1 / 0.2°F	Örnekleme oranı	Hızlı: 125 ms Yavaş: 1000 ms	Rüzgar hızı çözünürlüğü	0.1 m / s
Nem	% 0 bağıl nem ~ % 100 bağıl nem	Nem	% 0 bağıl nem ~ % 100 bağıl nem	Frekans tepkisi	31,5 Hz ~ 8 kHz	Sıcaklık	-10 ~ 50 °C 14 ~ 122 °F
Nem doğruluğu	± 5 RH	Nem doğruluğu	± 5 RH			Sıcaklık doğruluğu	± 2 °C / ± 4 °F
Nem çözünürlüğü	% 0.1 bağıl nem	Nem çözünürlüğü	% 0.1 bağıl nem			Sıcaklık çözünürlüğü	0.1 / 0.2°F
Örnekleme oranı	1 / sn	Örnekleme oranı	1 / sn			Rüzgar ölçüğü	Seviye 0 ~ 12

MİNİ LÜKSMETRE



KARBONDİOKSİT ÖLÇER



TAKOMETRELER



UT-383BT		UT-337A		UT-372		UT-373	
FİYATI : \$85,50		FİYATI : \$280,60		FİYATI : \$271,50		FİYATI : \$67,90	
Teknik Özellikler	Aralık	Teknik Özellikler	Aralık	Teknik Özellikler	Aralık	Teknik Özellikler	Aralık
Aydınlık ölçümü (LUX)	0 ~ 199,900Lux	CO Ölçüm Aralığı	0 ~ 1000 ppm	RPM aralığı	10RPM ~ 999RPM	RPM ölçümü	10.0 ~ 9999.9RPM
Aydınlık ölçümü (Fc)	0 ~ 18,500Fc	Doğruluk çözüm	±% 5 veya 5 ppm 1 ppm		100RPM ~ 999RPM		10000 ~ 99999RPM
Doğruluk	0 ~ 9999Lux / 0 ~ 999Fc: ± (% 4 + 8) ≥10000Lux / ≥1000Fc: ± (% 5 + 10)	Tepki Süresi	<60s (okumanın% 90'i)	Sayar	1000RPM ~ 9999RPM	Sayma ölçümü	0 ~ 99999 sayım
	≥100000Lux / ≥9999Fc: ± (% 5 + 10)	Sensör Tipi	Elektrokimyasal Gaz Sensörü (CO)		10000RPM ~ 99999RPM		
		Örnekleme Yöntemi	Difüzyon	Hedef uzaklığı	Aralık: 0 ~ 99999 Maks. Alan sayısı giriş frekansı: 10kHz; bant genişliği:% 5		
Çözüm	1Lux (0 ~ 9999Lux) 10Lux (≥10.000Lux) 100Lux (≥100.000Lux) 1Fc (0 ~ 9999Fc); FC = Lüks / 10.76 10Fc (-10,000Fc); FC = Lüks / 10.76						

MİNİ AHŞAP NEM ÖLÇER



FAZ SIRASI VE MOTOR ROTASYON



UT-377A		UT-261A	
FİYATI : \$75,90		FİYATI : \$172,50	
Teknik Özellikler	Aralık	Teknik Özellikler	Aralık
Ahşap nem ölçümü (%)	% 2 ~ 40	AC voltajı (V)	40V ~ 690V
		Frekans (Hz)	15 Hz ~ 400 Hz
		Çalışma akımı (A)	1mA

FAZ DEDEKTÖRÜ



AC VOLTAJ DEDEKTÖRLERİ



VOLTAJ TEST CİHAZI



UT-262A		UT-12D		UT-12E		UT-15C	
FİYATI : \$368,00		FİYATI : \$23,00		FİYATI : \$35,90		FİYATI : \$115,00	
Teknik Özellikler	Aralık	Teknik Özellikler	Aralık	Teknik Özellikler	Aralık	Teknik Özellikler	Aralık
Faz sırası	[Pozitif faz] saat yönünde dört fazlı ışıklar ve bip sesi	AC voltajı (Düşük)	AC voltajı (Düşük)	24V ~ 1000V	LED AC / DC voltaj göstergesi (V)	12V	0 ~ 12V
	[Negatif faz] saat yönünün tersine dört faz yanar ve sağlam ses	AC voltajı (Yüksek)	AC voltajı (Yüksek)	90V ~ 1000V		24V	17V ± 2V
Eksik faz tespiti	RS veya ST ışığı kapalı	Frekans aralığı	Frekans aralığı	50 / 60Hz		50V	35V ± 5V
Canlı güç algılama	RS veya ST ışığı yanıyor	Dahili flaş ışığı	Titreşim modu	✓		120V	80V ± 15V
Devre kesilmesi tespiti	RS veya ST ışığı kapalı	Sesli (sesli) ve görsel (LED) gösterge	Dahili flaş ışığı	✓		230V	165V ± 20V
Gerilim algılama	RS veya ST ışığı yanıyor	Buzzer	Sesli (sesli) ve görsel (LED) gösterge	✓		400V	300V ± 30V
Frekans aralığı (Hz)	40 Hz ~ 70 Hz	LED göstergesi	LED göstergesi	✓		690V	510V ± 40V
		Otomatik güç Off	Buzzer	✓			
		Düşük voltaj göstergesi	LED göstergesi	✓			
		Düşme testi	Otomatik güç off	✓			
			Düşük voltaj göstergesi	✓			
			Çift enjeksiyonlu kalıplama	✓			
			Düşme testi	2a			

KABLO TAKİP CİHAZI



UT-682			UT-682D			
FİYATI : \$118,50			FİYATI : \$67,90			
Teknik Özellikler	Aralık		Teknik Özellikler	Aralık		
Tel izleme özellikleri	Tel türleri	LAN kablosu \ telefon hattı \ koaksiyel kablo \ elektrik kablosu	Tel izleme özellikleri	Tel türleri	Telefon hattı \ bükülmüş çift \ elektrik kablosu	
	Sinyal gücü için gösterge ışığı	✓		Telefon hatları izleme mesafesi	≥3000m	
	Canlı santral tel izleme	✓		Telefon hatları için polarite göstergesi	DCV işlevi, aralık: ± (5V ~ 52V)	
	Santral tel izleme mesafesi	≥100m		Telefon hatları ve LAN kabloları ayırımı	Jacks ayırımı	
	Telefon hatları izleme mesafesi	≥3000m		Verici çıkış voltajı	Yeni pil ile 8V DC	
	Korumasız kablolar izleme mesafesi	≥320m		Verici güç kaynağı	9V pil	
	Korumalı kablolar izleme mesafesi	≥320m		Alıcı güç kaynağı	9V pil	
	Açık ve kısa devre testi	✓		Maksimum alıcı bekleme akımı	~ 10mA	
	Telefon hatları için polarite göstergesi	DCV işlevi, aralık: ± (5V ~ 52V)		Maksimum alıcı çalışma akımı	<40mA (AC, RMS)	
	Telefon hatları ve LAN kabloları ayırımı	Jacks ayırımı		Verici giriş voltajı koruması	60V DC	
	Kırık tel takibi	✓		Çalışma ortamı	Çalışma sıcaklığı: 0 ~ 40 °C; Saklama sıcaklığı: -10 ~ 50 °C	
	Verici çıkış voltajı	≥12V tepe tepe			Çalıştırma nemi: %20 ~ 75 RH; Depolama nemi: %10 ~ 90 Bağıl Nem; Rakım: ≤2000m	
	Verici düşük pil göstergesi	6.6V ± 0.5V				
	Verici güç kaynağı	9V pil				
	Maksimum verici çalışma akımı	25mA				
	Alıcı için kulaklık jakı	✓				
Alıcı güç kaynağı	9V pil					
Maksimum alıcı bekleme akımı	~ 10mA					
Maksimum alıcı çalışma akımı	<40mA (AC, RMS)					
Tel hizalama	Hat dizisi ölçümü	9 LED (LED1 ~ LED8, LED_G)				
	Hat sırası ölçüm hızı	Hızlı ve yavaş seçilebilir				
	LAN kablosu: korumalı / korumasız gösterge	✓				
	Verici giriş voltajı koruması	52V DC				
Çalışma ortamı	Çalışma sıcaklığı: 0 ~ 40 °C; Saklama sıcaklığı: -10 ~ 50 °C					
	Çalıştırma nemi: %20 ~ 75 RH; Depolama nemi: %10 ~ 90 Bağıl Nem; Rakım: ≤2000m					

EL TİPİ İZOLASYON DİRENCİ TEST CİHAZI



PENS TİPİ TOPRAKLAMA MEĞERİ



UT-505B		UT-276A+		UT-278A+	
FİYATI : \$1.069,50		FİYATI : \$1.288,00		FİYATI : \$1.495,00	
Teknik Özellikler	Aralık	Teknik Özellikler	Aralık	Teknik Özellikler	Aralık
50V	50V / 100V / 250V / 500V / 1000V	Sertifikalalar	CE, RoHS (yalnızca UT276A+ / 278A+)	Sertifikalalar	CE, RoHS
	0.01MΩ ~ 50MΩ	Kategori derecelendirmeleri	CAT III 300V	Kategori derecelendirmeleri	CAT III 300V
100V	50MΩ ~ 1GΩ	Topraklama Direnci (Ω)	0.01 ~ 0.099Ω	Topraklama Direnci (Ω)	0.01 ~ 0.099Ω
	1GΩ ~ 10GΩ		0,1 ~ 0,99Ω		0,1 ~ 0,99Ω
250V	0.01MΩ ~ 100MΩ		1 ~ 49.9Ω		1 ~ 49.9Ω
	100MΩ ~ 1GΩ		50 ~ 99.5Ω		50 ~ 99.5Ω
500V	1GΩ ~ 20GΩ		100 ~ 199Ω		100 ~ 199Ω
	0.01MΩ ~ 200MΩ		200 ~ 395Ω		200 ~ 395Ω
1000V	200MΩ ~ 1GΩ	400 ~ 590Ω	400 ~ 590Ω	400 ~ 590Ω	400 ~ 590Ω
	1GΩ ~ 100GΩ	Ekran sayısı	4 basamaklı LCD ekran	Ekran sayısı	600 ~ 800Ω
	0.01MΩ ~ 500MΩ	Çene açıklığı	32 mm	Çene açıklığı	800 ~ 1200Ω
	500MΩ ~ 1GΩ	Görsel ve sesli alarm	✓	Kaçak akım (A)	0mA ~ 9mA
	1GΩ ~ 100GΩ	Otomatik kapanma	✓		10mA ~ 99mA
	0.1MΩ ~ 2000MΩ	Sıkışma sinyali tanıma	✓		100mA ~ 299mA
	2GΩ ~ 9.9GΩ	Aralık üstü ekran	✓		0,3 A ~ 2,99 A
	10GΩ ~ 20GΩ	Veri depolama	300		3A ~ 9,9A
	20GΩ ~ 200GΩ	Ekran tipi	EBTN	10A ~ 20A	
Yük akımı	50V (R = 50kΩ) 1mA			Ekran sayısı	EBTN
	100V (R = 100kΩ) 1mA			Çene açıklığı	32 mm
	250V (R = 250kΩ) 1mA			Görsel ve sesli alarm	✓
	500V (R = 500kΩ) 1mA			Otomatik kapanma	✓
	1000V (R = 1MΩ) 1mA			Sıkışma sinyali tanıma	✓
Kısa devre akımı	<2mA			Aralık üstü ekran	✓
Kaçak akım (A)	10 ~ 2000µA			Veri depolama	300
Düşük direnç (Ω)	0.01Ω ~ 100Ω (yaklaşık 5V / > 200mA / 20mA isteğe bağlı)			Ekran tipi	EBTN
Genel direnç (Ω)	0.01kΩ ~ 10MΩ			Ω + A ekran	✓
DC voltajı (V)	0V ~ 600V				
AC voltajı (V)	0V ~ 600V				
Frekans (Hz)	45 ~ 1 kHz				
Kapasite (F)	100pF ~ 500µF				

PROBLAR



UT-L17 PROB LED IŞIKLI	UT-20 PROB	UT-21 PROB
FİYATI : \$19,60	FİYATI : \$7,00	FİYATI : \$9,50
Teknik Özellikler	Teknik Özellikler	Teknik Özellikler
Kurşun uzunluğu: 1000mm	Kablo uzunluğu: 900 mm, Çubuk uzunluğu: 101 mm	Kablo uzunluğu: 900 mm, Çubuk uzunluğu: 133 mm
Uç uzunluğu: 16 mm	Uç uzunluğu: 16,5 mm	Uç uzunluğu: 15,8 mm
Güvenlik seviyesi: CAT II 1000V 10A	Güvenlik seviyesi: CAT I 1000V / CAT II 600V 10A	Güvenlik seviyesi: CAT III 1000V / CAT IV 600V 20A
Kontrol edilebilir LED ışık kaynağı, tüm multimetreler ve spesifikasyon dahilinde ölçüm yapan kelepçeler	Koruyucu manşonlu çapraz fiş, genel tip probalar, tüm multimetreler ve zekayı ölçen kelepçeler	Koruyucu kılıflı çapraz fiş, genel tip probalar, tüm multimetreler ve kelepçeler

İZOLASYON DİRENÇİ TEST CİHAZI



UT-501A		UT-502A	
FİYATI : \$219,50		FİYATI : \$398,00	
Teknik Özellikler	Aralık	Teknik Özellikler	Aralık
Test voltajları	100V / 250V / 500V / 1000V	Test voltajları	500V / 1000V / 2500V
100V	0MΩ ~ 100MΩ	500V	0MΩ ~ 99.9MΩ 100MΩ ~ 5GΩ
250V	0MΩ ~ 99.9MΩ 100MΩ ~ 5GΩ	1000V	0MΩ ~ 99.9MΩ 100MΩ ~ 5GΩ
500V	0MΩ ~ 99.9MΩ 100MΩ ~ 5GΩ	2500V	0MΩ ~ 99.9MΩ 100MΩ ~ 9.9GΩ 10GΩ ~ 20GΩ
1000V	0MΩ ~ 99.9MΩ 100MΩ ~ 5GΩ	Yük akımı	50V (R = 50kΩ) 1mA 100V (R = 100kΩ) 1mA 250V (R = 250kΩ) 1mA 500V (R = 500kΩ) 1mA 1000V (R = 1MΩ) 1mA
Yük akımı	50V (R = 50kΩ) 1mA 100V (R = 100kΩ) 1mA 250V (R = 250kΩ) 1mA 500V (R = 500kΩ) 1mA 1000V (R = 1MΩ) 1mA	Kısa devre akımı	<2mA
Kısa devre akımı	<2mA	AC voltajı (V)	30V ~ 750V
AC voltajı (V)	30V ~ 750V	Düşük direnç (Ω)	0.01Ω ~ 200Ω (yaklaşık 5.0V / > 200mA)
		AC voltajı (V)	30V ~ 600V



UT-511		UT-513A	
FİYATI : \$416,00		FİYATI : \$1.295,00	
Teknik Özellikler	Aralık	Teknik Özellikler	Aralık
Test voltajları	100V ~ 1000V	Test voltajları	500V ~ 5000V
100V	0.1MΩ ~ 500MΩ	500V	0.5MΩ ~ 20GΩ
250V	0.5MΩ ~ 2GΩ	1000V	1MΩ ~ 40GΩ
500V	1MΩ ~ 4GΩ	2500V	2.5MΩ ~ 100GΩ
1000V	2MΩ ~ 10GΩ	5000V	5MΩ ~ 1000GΩ
DC voltajı (V)	1000V	DC voltajı (V)	600V
AC voltajı (V)	750V	AC voltajı (V)	600V
Kısa devre akımı	<2mA	Kısa devre akımı	> 3mA
Düşük direnç (Ω)	0.1Ω ~ 999.9Ω		

TOPRAKLAMA TEST CİHAZI



UT-521		UT-522	
FİYATI : \$545,00		FİYATI : \$582,00	
Teknik Özellikler	Aralık	Teknik Özellikler	Aralık
Toprak direnci (Ω)	0 ~ 20Ω 0 ~ 200Ω 0 ~ 2000Ω	Toprak direnci (Ω)	0 ~ 40Ω 0 ~ 400Ω 0 ~ 4000Ω
AC toprak gerilimi (V)	0 ~ 200V Frekans: 50Hz / 60Hz	AC toprak gerilimi (V)	0 ~ 400V Frekans: 50Hz / 60Hz

Weiller®



SIKMA PENSESİ	
KOD	HD-10300
FİYAT	\$250,00
ÖZELLİK	Plastik Çantalı Set 10-300 mm ² Hidrolik Bakır SKP Altıgen Sıkma 10-240 mm ² Hidrolik Alüminyum SKP Altıgen Sıkma



SIKMA PENSESİ	
KOD	HD-1070
FİYAT	\$175,00
ÖZELLİK	Plastik Çantalı Set 10-70 mm ² Hidrolik Bakır SKP Altıgen Sıkma



SKP SIKMA PENSESİ	
KOD	ESP-300
FİYAT	610,00€
ÖZELLİK	16-300 Mekanik SKP Sıkma Pensesi



SKP SIKMA PENSESİ	
KOD	ESP-150
FİYAT	385,00€
ÖZELLİK	10-150 Mekanik SKP Sıkma Pensesi



KOD	AR-115-1400
FİYAT	\$330,00
ÖZELLİK	İzoleli ve İzolesiz Yüksük ve Pabuç Sıkma Pensesi. Çene Takımları Değişebilmektedir. Kablo Sıyırma Pensesi.



PANÇ DELME SETİ	
KOD	MPD-PANCH
FİYAT	\$460,00
ÖZELLİK	Mekanik Panç Delme Seti Ø20.5-PG13.5 / Ø22.5-PG16 / Ø28.5-PG21 Ø37.5-PG28 / Ø47-PG36 / Ø61-PG48



YÜKSÜK SIKMA PENSESİ

KOD	YSP-6 / YAC-5	-	YSP-16 / YAC-6	YSP-6NW	A/YSP-6W / YAC-8
FİYAT	\$84,00	-	\$84,00	\$100,00	\$102,00
ÖZELLİK	0.5-6 mm ²	-	6-16 mm ²	0.5-6 mm ²	0.5-6 mm ²



YÜKSÜK SIKMA PENSESİ

KOD	YYT-22	YYT-21	YYT-23
FİYAT	\$31,00	\$40,00	\$44,00
ÖZELLİK	Yüksük Sıkma Pensesi 0.25/2.5 mm	Yüksük Sıkma Pensesi 6/10/16 mm	Yüksük Sıkma Pensesi 10/16/25/35 mm

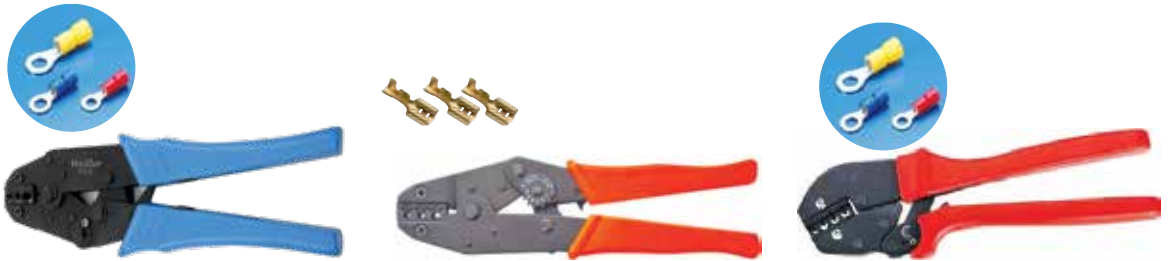

İZOLELİ ve İZOLESİZ PABUÇ SIKMA PENSESİ

KOD	İPS-6 / YYT-7	YYT-11	YYT-10
FİYAT	\$88,00	\$88,00	\$88,00
ÖZELLİK	1,5-2,5-4-6 mm İzoleli Pabuç Sıkma	İzolesiz Terminal Sıkma Pensesi	Noktasal Sıkma,0.5-1.5/1.5-2.5/4-6/6-10mm İzoleli - İzolesiz Pabuç Sıkma

Weiller®



KONNEKTÖR SIKMA PENSESİ	
KOD	PT-86
FİYAT	\$60,00
ÖZELLİK	CAT5 Telefon Konnektör Sıkma Pense 6p/8p Konnektör Sıkma Pense



KONNEKTÖR SIKMA PENSESİ	
KOD	PT-8
FİYAT	\$48,00
ÖZELLİK	CAT5 Telefon Konnektör Sıkma Pense 6p/8p Konnektör Sıkma Pense



KABLO KESME MAKASI	
KOD	WKKM
FİYAT	\$118,00
ÖZELLİK	Plastik Pano Kanalı Kesme Makası



KABLO AÇMA	
KOD	KP-5
FİYAT	\$37,00
ÖZELLİK	0.25 - 2.5 mm ² Kablo Açma



KABLO AÇMA		
KOD	JK-385H	No: 16
FİYAT	36,00€	63,00€
ÖZELLİK	4 - 28 mm ² Kablo Açma	Ø8 - 13 mm ² Kablo Sıyırma 0,75 - 6 mm ² Kablo Açma

Ø 22mm max.



*Çelik Tel ve Çelik İzoleli Kablo Kesmeyiniz.

KABLO KESME MAKASI	
KOD	TC-125S
FİYAT	\$170,00
ÖZELLİK	Max. 1x150 NYAF 120 mm ² Kablo Kesme Makası Teleskopik Kol

Ø 48mm max.



A/PC-500

Ø 38mm max.



A/PC-250

Ø 22mm max.



A/PC-125

*Çelik Tel ve Çelik İzoleli Kablo Kesmeyiniz.

KABLO KESME MAKASI			
KOD	PC-125	PC-250	PC-500
FİYAT	\$100,00	\$150,00	\$270,00
ÖZELLİK	Max. 1x150 NYAF 4x10 NYY	Max. 1x240 NYAF 3x50+25 NYY	Max. 3x95+50 NYY



KOD	SFK-5 / YAC5
FİYAT	\$137,20

0,50 - 6,00 mm² arası izoleli ve izolesiz kablo yüksükleri sıkar.
Cırcırlı sıkma mekanizması ve kuvvet ayarı mevcuttur.
Sapları plastik izolelidir.
Terminal / Konnektör Tipi



KOD	SFK-6 / YAC-6
FİYAT	\$137,20

6,00 - 16,00 mm² arası izoleli ve izolesiz kablo yüksükleri sıkar.
Cırcırlı sıkma mekanizması ve kuvvet ayarı mevcuttur.
Sapları plastik izolelidir.
Terminal / Konnektör Tipi



KOD	SFK-8 / YAC-8
FİYAT	\$166,50

0,80 - 6,00 mm² arası izoleli ve izolesiz kablo yüksükleri sıkar.
Cırcırlı sıkma mekanizması mevcuttur.
Kare formda sıkma yapar.
Sapları plastik izolelidir
Terminal / Konnektör Tipi



KOD	SFK-7 / YYT-7
FİYAT	\$137,20

İzoleli Terminalleri Sıkır
Çift Taraflı Sıkma yapar
Sıkma Çeneleri ve gövdesi çeliktir
Cırcırlı sıkma mekanizması ve kuvvet ayarı mevcuttur
Sapları plastik izolelidir
Terminal / Konnektör Tipi



KOD	SFK-11 / YYT-11
FİYAT	\$137,20

İzolesiz Terminalleri Sıkır
Sıkma Çeneleri ve gövdesi çeliktir
Cırcırlı sıkma mekanizması ve kuvvet ayarı mevcuttur
Sapları plastik izolelidir
Terminal / Konnektör Tipi



KOD	CT-25
FİYAT	\$198,80

6,00 - 25,00 mm² arası SKP kablo pabuçlarını sıkar.
Nokta sıkma yapar.
Cırcırlı sıkma mekanizması mevcuttur.
Sapları plastik izolelidir.
Terminal / Konnektör Tipi



KOD	SFK-T8 / YYT-8
FİYAT	\$118,50

1,50 - 10,00 mm² arası SKP kablo pabuçlarını sıkar.
Sıkma çeneleri ve gövdesi çeliktir.
Cırcırlı sıkma mekanizması ve kuvvet ayarı mevcuttur.
Sapları plastik izolelidir.
Terminal / Konnektör Tipi



KOD	SFK-9 / YYT-9
FİYAT	\$118,50

10,00 - 16,00 mm² arası SKP kablo pabuçlarını sıkar.
Sıkma çeneleri ve gövdesi çeliktir.
Cırcırlı sıkma mekanizması ve kuvvet ayarı mevcuttur.
Sapları plastik izolelidir.
Terminal / Konnektör Tipi



KOD	SKS-318
FİYAT	\$62,50
YY-78-318 0,50-2,5 mm ² KABLO SIYIRMA PENSESİ	



KOD	WSC-1022
FİYAT	\$45,20
0,50 - 6,00 mm ² kabloları sıyırır. Tek damarlı NYF kabloları sıyırır. Yaylı	



KOD	MES-202
FİYAT	\$128,30
0,50 - 6,00 mm ² kabloları sıyırır. Tek damarlı NYF kabloları sıyırır. Yaylı	



KOD	LY-700B
FİYAT	\$85,00
1,0 - 4,0 mm ² arası çok telli ve Ø 1,0 - 3,2 mm tek telli kabloları sıyırır. Geri açılma yayı mevcuttur. Sapları plastik izolelidir.	



KOD	SP-0650STD
FİYAT	145,00€
6,00 - 50,00 mm ² arası SKP STANDART kablo pabuçlarını sıkır. Altıgen sıkma yapan dönen çenelidir. Sapları plastik izolelidir.	



KOD	SP-10120STD
FİYAT	226,00€
10,00 - 120,00 mm ² arası SKP STANDART kablo pabuçlarını sıkır. Altıgen sıkma yapan dönen çenelidir. Sapları plastik izolelidir.	



KOD	KM-95
FİYAT	91,00€
NYA-NYY ve NYM bakır ve alüminyum kabloları keser. Kolları çelik borudur. Sapları plastik izolelidir.	



KOD	KM-240
FİYAT	126,50€
NYA-NYY ve NYM bakır ve alüminyum kabloları keser. Kolları çelik borudur. Sapları plastik izolelidir.	



KOD	KKM
FİYAT	\$171,70
Kablo Kanalı Kesme Makası	

STEINEL®

PROFESSIONAL

MADE IN GERMANY



STEINEL GLUEFIX SICAK SILIKON TABANCASI	
KOD	333911
FİYAT	60,00€
Silikon	11mm.
Isınma	7-8 Dakika
Güç	175W
Ebat	173x30x125mm.
Ağırlık	300 Gram

STEINEL GLUEMATIC 3002 SILIKON TABANCASI	
KOD	333317
FİYAT	75,00€
Silikon	11mm.
Isınma	7-8 Dakika
Güç	200W
Ebat	185x30x160mm.
Ağırlık	320 Gram



STEINEL HL 1400 S - 1400 WATT	
KOD	345914
FİYAT	120,00€
Güç	1400W
Isı	300/500 °C
Hava	240/450 Lt/Dk
Kablo	2.2m.
Ebat	252x85,5x200mm.
Ağırlık	670 Gram



STEINEL HL 1620 S - 1600 WATT	
KOD	351106
FİYAT	147,00€
Güç	1600W
Isı	300/500 °C
Hava	240/450 Lt/Dk
Kablo	2.2m.
Ebat	252x85,5x200mm.
Ağırlık	670 Gram



STEINEL HL 1820 S - 1800 WATT	
KOD	033316
FİYAT	211,00€
Güç	1800
Isı	50/400/600 °C
Hava	150/300/500 Lt/Dk
Kablo	2.2m.
Ebat	252x85,5x200mm.
Ağırlık	800 Gram



STEINEL HL 1920 E - 2000 WATT	
KOD	352103
FİYAT	247,00€
Güç	2000W
Isı	80-600 °C
Hava	150-500 Lt/Dk
Kablo	2.2m.
Ebat	253x84,5x200mm.
Ağırlık	840 Gram





FİBER OPTİK SIYIRICI	
KOD	JIC-125
FİYAT	\$155,00
Kesme Tipi	Sıyırma
Kablo Tipi	Fiber Optik
Kablo Çapı	250-125 Mikron
Sap	TPR (Kauçuk)
Renk	Sarı
Boy	130mm.



AYARLANABİLİR KABLO SOYMA KESME	
KOD	WS-5
FİYAT	\$49,00
	10-30 AWG (2.6-0.25mm.v)
Boy	127mm.



KABLO ÇEKETİ ve FİBER OPTİK SIYIRICI	
KOD	JIC-1022
FİYAT	\$54,00
Kesme Tipi	Sıyırma
Kablo Tipi	Kablo Çeketi
Kablo Çapı	2.0 - 3.0mm.
Sap	TPR (Kauçuk)
Renk	Sarı
Boy	170mm.



KONNEKTÖR PENSESİ (YANKESKİLİ)	
KOD	JIC-891
FİYAT	\$91,50
Boy	130mm.
UR/UY/UG, AMP,709 Serisi "B" tip konnektörleri sıkamak için.	



COAXIAL KABLO SOYMA ALETİ	
KOD	UST-1596
FİYAT	71,00€
Boy	121mm.
RG59/6 için kablo stoplu, çift bıçaklı.	



KABLO SOYMA & KESME ALETİ 127mm	
KOD	UST-500
FİYAT	79,00€
İzolesiz Terminalleri Sıkarak Sıkma Çeneleri ve gövdesi çeliktir Cırcırlı sıkma mekanizması ve kuvvet ayarı mevcuttur Sapları plastik izolelidir Terminal / Konnektör Tipi	

STEWELD

MADE IN PRC



LED IŞIKLI MASA BÜYÜTECİ LOOP

KOD	8093LED
FİYAT	\$223,00
Lens	4"
Diyopter	3+12
Voltaj	220-240
Işık	60 Adet Led
Ayak	Masaüstü
Renk	Beyaz

LED IŞIKLI MASA BAĞLANTILI BÜYÜTEÇ LOOP

KOD	8066LED
FİYAT	\$336,00
Lens	5"
Diyopter	3
Voltaj	220-240
Işık	90 Adet Led
Ayak	Masa Mengeneği
Renk	Beyaz



EKONOMİK LED KAFA LAMBASI

KOD	STW-5825
FİYAT	\$19,00
	80 Lümen
	1W Powerfull Led
	3x AAA Pil (İçermez)
	Oynar Kafa, Sağlam Plastik Gövde
Ebat	58x82x64mm.
Ağırlık	80 Gram

EKONOMİK LED KAFA LAMBASI

KOD	STW-578
FİYAT	\$11,50
	10 Adet Ultra Parlak Led
	3x AAA Pil (İçermez)
	Oynar Kafa, Sağlam Plastik Gövde
Ebat	70x50x50mm.
Ağırlık	72 Gram



OYNAR BAŞLIKLILIK LED ÇALIŞMA IŞIĞI

KOD	STW-592
FİYAT	\$12,00
	24 Adet Beyaz Led
	3x AAA Pil (İçermez)
	Mıknatıslı Ayak
Ebat	68x60mm.
Ağırlık	72 Gram

LED FENER

KOD	STW-568B
FİYAT	\$17,50
	Çift Fonksiyonlu
	36+1 Beyaz Alan Lambası ve Fener Modu
	4x AAA Pil (İçermez)
Ebat	217x27x17mm.
Ağırlık	64 Gram

JOKARI®
original

MADE IN GERMANY

Hassas Kablo & Tel Soyma Aletleri

Kablo soyma bıçağı

System 4-70 (No. 28 kablo dirseğı ile)

En yaygın kablo türleri için akıllı, deęiřtirilebilir bir dirsek sistemi

Çift bıçaklı sisteme sahiptir;

Önde standart ve arka tarafından çıkan çengel bıçak

8 - 28 mm Ø

0,31" - 1,10" Ø

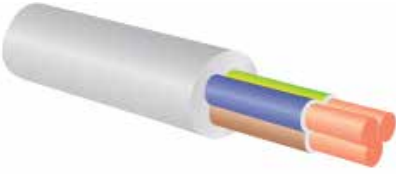

Kod No: 70000 Fiyat: 143,00€

Yedek ve opsiyonel dirsekler

En yaygın kablo türleri için akıllı, deęiřtirilebilir bir dirsek sistemi

Kablo dirseğı No. 16 4-16mm 0.16" - 0.63" Ø

Kod No: 79016 Fiyat: 65,00€

Kablo dirseğı No. 28 8-28mm 0.31" - 1.10" Ø

Kod No: 79028 Fiyat: 65,00€

Kablo dirseğı No. 35 27-35mm 1.06" - 1.38" Ø

Kod No: 79035 Fiyat: 76,00€

Kablo dirseğı No. 50 35-50mm 1.38" - 1.97" Ø

Kod No: 79050 Fiyat: 76,00€

Kablo dirseğı No. 70 50-70mm 1.97" - 2.75" Ø

Kod No: 79070 Fiyat: 76,00€

Yedek kablo bıçağı Yedek çengel bıçak

Kod No: 19000 Fiyat: 14,50€



Kablo soyma bıçağı

System 4-70 SET

Tüm kablo dirseklerine sahiptir.

Yüksek kalite süngere sahip Sortimo çanta içerisinde gelir

Kod No: 71000

Fiyat: 375,00€



JOKARI Kablo ve Tel Soyma Aletleri

KABLO SOYMA BIÇAĞI

No.16 Standart + 1 adet yedek bıçak ile
Daha iyi tutuş ve güvenlik için çift birleşik sap
4 - 16 mm Ø
5/32" - 5/8" Ø



Kod No: 10162

Fiyat: 25,00€

KABLO BIÇAKLARI YEDEK AĞIZLAR



Tek bıçak; No.16, 27, 28, 35, 50 modelleri için

Kod No: 19000

Fiyat: 14,50€

Üçlü paket; No.16, 27, 28, 35, 50 modelleri için

Kod No: 19000/3

Fiyat: 43,00€

Koruma kapağı



Tek bıçak; No.28 modelleri için

Kod No: 19580

Fiyat: 9,50€

KABLO SOYMA BIÇAĞI

No.16 Secura + 1 adet yedek bıçak ile
yumuşak baş parkmak desteği
4 - 16 mm Ø
5/32" - 5/8" Ø



Kod No: 10160

Fiyat: 34,70€

KABLO SOYMA BIÇAĞI

No.27 Standart + 1 adet yedek bıçak ile
Daha iyi tutuş ve güvenlik için çift birleşik sap
8 - 28 mm Ø
5/16" - 1.1/8" Ø



Kod No: 10272

Fiyat: 27,20€

KABLO SOYMA BIÇAĞI

No.27 ISO + 1 adet yedek bıçak ile
Bıçak hairç ful plastik dizayn
8 - 28 mm Ø
5/16" - 1.1/8" Ø



Kod No: 10271

Fiyat: 41,00€

KABLO SOYMA BIÇAĞI

No.27 Secura + 1 adet yedek bıçak ile
yumuşak baş parkmak desteği
8 - 28 mm Ø
5/16" - 1.1/8" Ø



Kod No: 10270

Fiyat: 35,00€

KABLO SOYMA BIÇAĞI

No.35 Standart + 1 adet yedek bıçak ile
Daha iyi tutuş ve güvenlik için çift birleşik sap
27 - 35 mm Ø
1.5/64" - 1.1/2" Ø



Kod No: 10350

Fiyat: 62,50€

KABLO SOYMA BIÇAĞI

No.35 P + 1 adet yedek bıçak ile
Kağıt izoleli kablolar için tasarlanmıştır
35 - 300 mm² | insulation 3 - 5 mm



Kod No: 10355

Fiyat: 83,00€



KABLO SOYMA BIÇAĞI

No.50 Standart + 1 adet yedek bıçak ile
Daha iyi tutuş ve güvenlik için çift birleşik sap
35 - 50 mm Ø
1.3/8" - 1.15/16" Ø



Kod No: 10500

Fiyat: 82,50€

KABLO SOYMA BIÇAĞI

No.28 G Standart + 1 adet yedek bıçak ile
Düz bıçak
8 - 28 mm Ø
5/16" - 1.1/8" Ø



Kod No: 10285

Fiyat: 30,00€

Kablo soyma bıçağı

No.28 G Standart Secura + 1 adet yedek bıçak
Düz bıçak
8 - 28 mm Ø
15/16" - 1.1/8" Ø



Kod No: 10281

Fiyat: 37,80€

KABLO SOYMA BIÇAĞI

No.70 Standart + 1 adet yedek bıçak ile
Daha iyi tutuş ve güvenlik için çift birleşik sap
Ø 50 - 70 mm
1 31/32" - 2 3/4"



Kod No: 10700

Fiyat: 97,50€

KABLO SOYMA BIÇAĞI

No.28 H Standart + 1 adet yedek bıçak ile
Çengel bıçak
8 - 28 mm Ø
5/16" - 1.1/8" Ø



Kod No: 10282

Fiyat: 30,00€

KABLO SOYMA BIÇAĞI

No.28 H Standart secura + 1 adet yedek bıçak
Çengel bıçak
8 - 28 mm Ø
15/16" - 1.1/8" Ø



Kod No: 10280

Fiyat: 38,00€

JOKARI Kablo ve Tel Soyma Aletleri

UNIVERSAL SOYUCU NO.12

Universal Soyucu 3x1,5 dan 5x2,5mm kareye kadar NYM kabloları dahil tüm standart silindirik kablolar için uygundur. Kesme derinliği ayarı gerektirmez. TIN kaplı bıçaklar. Cep klipsli.

4 - 16 mm Ø
5/32" - 5/8" Ø



Kod No: 30120

Fiyat: 44,50€



NO.14 STRIP

Tüm standart PVC izoleli silindirik kablolar ve PVC izoleli düz kablolar için kablo soyma aleti. Uzunlamasına kesim için ekstra bıçak. Kesme derinliği ayarı gerektirmez. Kondüktörleri soymak için 3 adet soyma çentiği. Cep klipsli.

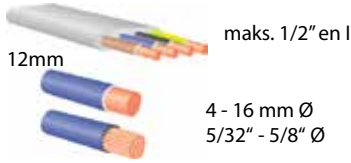

12mm

maks. 1/2" en l

4 - 16 mm Ø
5/32" - 5/8" Ø

Kod No: 30140

Fiyat: 58,00€



SECURA NO.15

Tüm standart silindirik kabloları soymak için kablo soyucu. NYM 3x1,5 dan 5x2,5mm kareye kadar, halojensiz NHXMH 3x1,5 dan 5x2,5mm kareye kadar. Kesme derinliği ayarı gerektirmez. TIN kaplı bıçaklar. Uzunlamasına kesim için ekstra bıçak. Kondüktörleri soymak için 6 adet soyma çentiği. Daha iyi tutuş ve güvenlik için çift bileşenli sap. Cep klipsli.

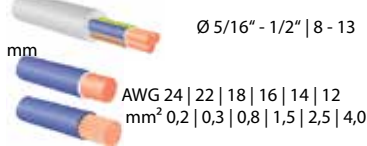

mm

Ø 5/16" - 1/2" | 8 - 13

AWG 24 | 22 | 18 | 16 | 14 | 12
mm² 0,2 | 0,3 | 0,8 | 1,5 | 2,5 | 4,0

Kod No: 30155

Fiyat: 81,00€



ALLROUNDER

Silindirik ve düz kablolar için soyucu. İnşaat servisi ve endüstriyel uygulamalar için çok amaçlı bir alet. Boylamasına kesim için ekstra bıçak. Kondüktörü soymak için uzunluk stoplu 2 soyma çentiği. Değişebilen uzunluk stopu sol ve sağ el kullanımına uygundur ve istenirse ortada da kullanılabilir. Kullanım alanı: 4-15 mm çapında silindirik kablolar; güç, kontrol, halojensiz uygulamalar, data, koaksiyal kablolar. Düz Kablolar maksimum 15mm; YDYD, NYM-J

Kod No: 30900

Fiyat: 59,00€



5/32" - 19/32" Ø | 4 - 15mm Ø

max. 19/32" | 15 mm

mm² 1,5 - 50

AWG 16 | 14
1,5 | 2,5mm kare



UNI-PLUS

Tüm standart izoleli silindirik kablolar, inşaat uygulaması ve endüstriyel kablolar için kablo soyma aleti. Kesme derinliği ayarı gerektirmez. Kondüktörleri soymak için uzunluk stoplu 2 adet soyma çentiği. Değişebilen uzunluk stopu sağ ve sol el kullanımına uygundur. Askı deliğine sahiptir.

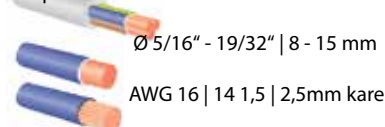

Ø 5/16" - 19/32" | 8 - 15 mm

AWG 16 | 14 1,5 | 2,5mm kare

Kod No: 30400

Fiyat: 46,00€

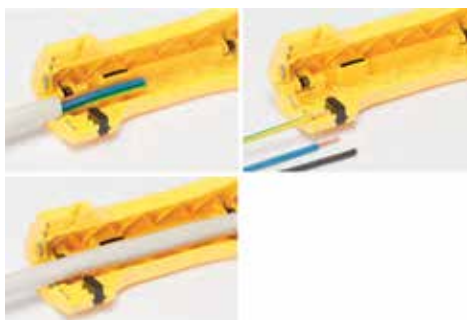

JOKARI kablo ve tel soyma aletleri

COAXI NO. 1

Tüm standart koaksiyal kablolar için kablo soyucu; TV, RG 58U/RG 59U, 3'lü flex (3x0.75mm kare) dahil. 20mm uzunluk skalalı. Kesme bıçakları doğru kullanım düzeni için her iki tarafta 1 ve 2 rakamları ile işaretlenmiştir. Kesme derinlik ayarı gerektirmez. Daha iyi tutuş ve güvenlik için çift bileşenli sap. TİN kaplı bıçaklar. Coaxi No. 1 Ekonomik model, tek renk ve sap SECURA Coaxi No. 1 Çift komponent renkli sap



Ø 3/16" - 19/64" | 4,8 - 7,5 mm

Kod: 30010 (Coaxi No.1) Fiyat: 40,00€

Kod: 30600 (SECURA) Fiyat: 46,70€



PC-CAT

PVC izoleli data iletişim ve kontrol bağlantıları (Cat5, Cat6, Cat7, çift bükümlü, network, ve ince izoleli kablolar) için özel, kılıf ve izole sıyırma aleti. Kesme derinlik ayarı gerektirmez. TİN kaplı bıçaklar. Cep klipsli.



Ø 3/16" - 3/8" | 4,5 - 10 mm

AWG 24 | 22 | 18

0,2 | 0,3 | 0,8mm kare

Kod No: 30161

Fiyat: 71,00€



PC-STRIP

PVC izoleli data iletişim, kontrol kabloları ve çeşitli Öflex tipleri için özel, kılıf ve izole soyucu aleti. Kesme derinlik ayarı gerektirmez. TİN kaplı bıçaklar. Cep klipsli.



Ø 3/16" - 1/2" | 5 - 13 mm

AWG 24 | 22 | 18 | 16 | 14 | 12

0,2 | 0,3 | 0,8 | 1,5 | 2,5 | 4,0mm

Kod No: 30160

Fiyat: 88,20€



SUPER 4 PLUS & SUPER 4

Sert ve standart kablolar için ergonomik ve otomatik tel kablo soyucu. Çap ayarı gerektirmez. Enine kesit tel kesimleri için AWG 14 | 2,5mm kareye kadar. 6 - 15 mm ayarlanabilir uzunluk stobu. Askı deliği. Değiştirilebilir ağızlar. Super 4 plus

AWG 24 - 10 / 0,2 - 6,0mm kare

Kod No: 20050 Fiyat: 63,50€

Kod No: 29050 Fiyat: 34,00€

Super 4 AWG 20 - 11 / 0,5 - 4,0mm kare

Kod No: 20040 Fiyat: 39,00€



SECURA 2K

Sert ve standart kablolar için ergonomik ve otomatik tel kablo soyucu. Çap ayarı gerektirmez. Enine kesit tel kesimleri için AWG 14 | 2,5mm kareye kadar. 6 - 18 mm ayarlanabilir uzunluk stobu. Güvenli çift bileşenli yumuşak kaymaz alana sahip dizaynı sap. Değiştirilebilir ağızlar AWG 24 - 10 0,2 - 6,0 mm kare



Kod No: 20100

Fiyat: 95,50€

Kod No: 29100

Fiyat: 52,50€



Kraftgrip®

MADE IN SLOVENIA



50000IR DÜZ UÇLU TORNAVIDALAR

ISO 2380-1
EN60900

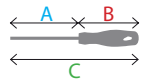

1000V

Kod	Ø	∅	A	B	C	→	↺	Fiyat
43929	0,4	2,5	75	85	160	2,5	10	6,90€
43931	0,8	4,0	100	85	185	3,5	10	8,90€
43932	1,0	5,5	125	100	225	5,0	10	10,30€
43933	1,2	6,5	150	110	260	6,0	10	13,50€



50020IR YILDIZ UÇLU TORNAVIDALAR

ISO 8764-1
EN60900

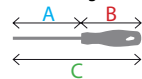

1000V

Kod	∅	∅	A	B	C	→	↺	Fiyat
44513	PH	0	60	85	145	3,0	10	7,70€
43934	PH	1	80	100	180	4,5	10	9,80€
43935	PH	2	150	110	210	6,0	10	10,60€



1000 V DVE GS

DÜZ - YILDIZ TORNAVIDA TAKIMI

7 PARÇA

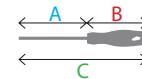

1000V

Kod	Ø	∅	A	B	C	→	↺	Fiyat
43904	0,4	2,5	75	85	160	2,5	32	48,10€
	0,5	3,0	100	85	185	3,0		
	0,8	4,0	100	85	185	3,5		
	1,0	5,5	125	100	225	5,0		
	1,2	6,5	150	110	260	6,0		
	PH	1	80	100	180	4,5		
	PH	2	100	110	210	6,0		



PT-2K 140 KONTROL KALEMI 140MM

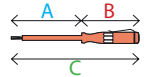

220-250V

Kod	Ø	∅	A	B	C	→	↺	Fiyat
7850	0,5	3,5	60	80	140	3,0	30	3,60€



PT-2K 180 KONTROL KALEMI 180MM

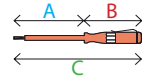

220-250V

Kod	Ø	∅	A	B	C	→	↺	Fiyat
7854	0,5	3,5	80	100	180	3,5	20	4,40€



70000 DÜZ UÇLU ELEKTRONİKÇİ TORNAVIDA

ISO 2380-1

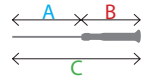

Kod	Ø	∅	A	B	C	→	↺	Fiyat
43937	0,2	1,5	60	95	155	2,5	10	7,60€
44535	0,4	2,0	60	95	155	2,5	10	7,30€
43939	0,4	2,5	75	95	170	2,5	10	7,00€
44536	0,5	3,0	60	95	155	3,0	10	6,80€
43940	0,5	3,0	100	95	195	3,0	10	7,20€
44537	0,8	4,0	60	95	155	4,0	10	7,10€
44538	0,8	4,0	100	95	195	4,0	10	7,30€
44539	0,8	4,0	125	95	220	4,0	10	7,60€



70020 YILDIZ UÇLU ELEKTRONİKÇİ TORNAVIDA

ISO 8764-1

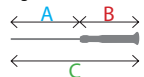

Kod	∅	A	B	C	→	↺	Fiyat
44540	PH000	60	95	155	2,5	10	8,80€
43941	PH00	60	95	155	2,5	10	8,30€
43942	PH0	60	95	155	3,0	10	6,80€
44541	PH1	80	95	175	4,5	10	6,90€



DÜZ-YILDIZ ELEKTRONİKÇİ TORNAVIDA TAKIMI

6 PARÇA

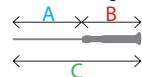

Kod	Ø	∅	A	B	C	→	↺	Fiyat
43927	0,2	1,5	60	95	155	2,5	12	40,80€
	0,3	1,8	60	95	155	2,5		
	0,4	2,5	75	95	170	2,5		
	0,5	3,0	100	95	195	3,0		
	PH	00	60	95	155	2,5		
	PH	0	60	95	155	3,0		



TORX ELEKTRONİKÇİ TORNAVIDA TAKIMI

6 PARÇA



Kod	∅	A	B	C	→	↺	Fiyat	
43928	T	6	60	95	155	3,0	12	40,80€
	T	7	60	95	155	3,0		
	T	8	60	95	155	3,0		
	T	9	60	95	155	3,0		
	T	10	60	95	155	3,0		
	T	15	60	95	155	3,5		

ELEKTRİKÇİ YANKESKİSİ

- Elektrik kurulumu ve kablolama için çok işlevli alet
- 1.5 ve 2.5 mm² özel ağızlar ile kolay sıyırma sağlar. Bakır teller ve hafif sert teller ve kablolar için idealdir. Keskin ağızlara sahip.



Kod No	Boy	Ağırlık	Fiyat
21-160 VDE	160mm	220gr.	105,00€

KARGABURUN (STANDART)

- Düz, yarım-yuvarlak, uzun ve ince, tırtıklı ve yankeskili
- Hassas işlem yapmak ve tel kesmek için



Kod No	Boy	Ağırlık	Fiyat
15-160 VDE	160mm	145gr.	65,00€
15-200 VDE	200mm	190gr.	70,00€

„EVOSHARK“ KABLO KESİCİ

- Bakırın temiz ve alüminyum kabloların pürüzsüz kesilmesi için ince kesme kenarı
- Sert çekilmiş bakır iletkenler veya çelik teller için değil
- Entegre yay ve tutma ile tek elle çalıştırma



Kod No	Boy	Ağırlık	Fiyat
47-180 VDE	180mm	305gr.	117,00€
47-220 VDE	220mm	380gr.	145,00€

KABLO SIYIRMA PENSESİ

- Tekli, çoklu ve ince telli tellerin soyulması için
- Yaylı, ayar vidalı ve kilit somunlu
- Maks. Ø 5.0 mm. 10 mm² kablo kesit alanı



Kod No	Boy	Ağırlık	Fiyat
48-160 VDE	160mm	165gr.	72,00€

YAN KESKİ (STANDART KULLANIM)

- Sert tel için (H)
- Çeşitli kullanımlar için hassas kesici kenarlar



Kod No	Boy	Ağırlık	Fiyat
28-140 VDE	145mm	175gr.	68,00€
28-160 VDE	160mm	220gr.	70,00€
28-180 VDE	180mm	280gr.	77,00€

EĞRİ KARGABURUN (STANDART)

- 40° eğri, yarım-yuvarlak, uzun ve ince, dişli çeneli ve yankeskili
- Hassas işlem yapmak, telleri kesmek için



Kod No	Boy	Ağırlık	Fiyat
17-160 VDE	160mm	145gr.	76,20€
17-200 VDE	200mm	190gr.	76,20€

KOMBİNE PENSE

- Sert tel için (H)



Kod No	Boy	Ağırlık	Fiyat
41-160 VDE	160mm	210gr.	62,00€
41-180 VDE	180mm	265gr.	65,00€
41-200 VDE	200mm	325gr.	73,00€

„TOOL BOX“ SET - 7 PARÇA.

- 1000 Volt izoleli 15-200, 28-160, 41-160, SL 4, SL 5,5; PH 2; ve Kontrol kalemi



Kod No	Ağırlık	Fiyat
76-717 VDE	1200gr.	159,00€



KABLO SIYIRICI Ø 2,0-6,0mm²

OTOMATİK

Boy	205mm
Ağırlık	300gr.

Kod LS-A318

\$72,50



KABLO SIYIRICI Ø 1,0-3,2mm²

OTOMATİK

Boy	180mm
Ağırlık	350gr.

Kod LS-700B

\$74,50



KONNEKTÖR SIKMA PENSESİ

8P8C/RJ-45, 6P6C/RJ12, 6P4C/RJ-11

Sıkma	4-6-8
Boy	195mm
Ağırlık	400gr.

Kod HY-200

\$53,10



KABLO MAKASI Ø 22mm²

BAKIR KABLolar İÇİN

Boy	160mm
Ağırlık	190gr.

Kod LK-22A

\$37,60



KABLO MAKASI Ø 38mm²

BAKIR KABLolar İÇİN

Boy	210mm
Ağırlık	210gr.

Kod LK-38A

\$56,00



KABLO MAKASI Ø 60mm²

BAKIR KABLolar İÇİN

Boy	230mm
Ağırlık	230gr.

Kod LK-60A

\$66,70



YÜKSÜK SIKMA PENSİ Ø 0,25-6mm²

180mm

Kod LSC8-6-4

\$120,00



PABUÇ SIKMA PENSİ

Ø 0,5-6mm²

0,5-6,0mm²

20-10AWG

Boy	215mm
Ağırlık	490gr.

Kod LY-30J

\$96,00



PIERGIACOMI

Elektronikçi yankeski

Boy	138mm
Kapasite	1,3mm'ye kadar bakır kablo

Kod TRE03NB

\$19,50



KABLO MAKASI

Kod	HCC-125	125mm ²	\$82,50
Kod	HCC-250	125mm ²	\$123,50
Kod	HCC-500	125mm ²	\$329,20



COAXIAL KABLO SOYMA ALETİ

Boy	125mm
Ağırlık	75gr.

Kod HY-302

\$41,50



KABLO SOYMA

AWG 22, 20, 18, 16, 14, 12, 10

0.60, 0.80, 1.0, 1.3, 1.6, 2.0, 2.6mm²

Boy	170mm
Ağırlık	130gr.

Kod HY-5021

\$37,00



HV-30



HV-40



HV-60



HV-80



HV-100



PTH-100



HV-150



HV-200



SHT-2000



SST

HAVYA, SICAK HAVA TABANCASI ve SİLİKON TABANCASI

KOD	ÖZELLİK	ADET	FİYAT (\$)
HV-30	30W Kalem Havya - Yanmaz Uçlu	1	\$21,00
HV-40	40W Kalem Havya - Yanmaz Uçlu	1	\$22,00
HV-60	60W Kalem Havya - Yanmaz Uçlu	1	\$26,00
HV-80	80W Kalem Havya - Yanmaz Uçlu	1	\$35,00
HV-100	100W Pro. Havya	1	\$39,00
HV-150	150W Pro. Havya	1	\$87,00
HV-200	200W Pro. Havya	1	\$98,00
PTH-100	100W Pro. Tabanca Havya	1	\$60,00
SHT-2000	2000W Sıcak Hava Tabancası	1	\$105,00
SST-55	55W Sıcak Silikon Tabancası	1	\$38,00
SST-80	80W Sıcak Silikon Tabancası	1	\$65,00
SST-100	100W Sıcak Silikon Tabancası	1	\$110,00



LP-10
\$14,00



Lehim pompası
ABS gövde
Boy: 197mm
Ağırlık: 38gr.
Kod: HY-208A
Fiyat: **\$12,00**



Lehim pompası
Alüminyum gövde
Boy: 197mm
Ağırlık: 65gr.
Kod: HY-018A
Fiyat: **\$12,00**



SS - Sıcak Silikon
Fiyat: **\$25,00**



HS-10
Fiyat: **\$12,00**



LEHİM ve YAN ÜRÜNLERİ

KOD	ÖZELLİK	ADET	FİYAT (\$)
LEHİM 0.75	0.75mm. 200Gr. Lehim Teli SOLDEX/FERAY	1	 LÜTFEN FİYAT SORUNUZ
LEHİM 0.75	0.75mm. 500Gr. Lehim Teli SOLDEX/FERAY	1	
LEHİM 1.2	1.2mm. 200Gr. Lehim Teli SOLDEX/FERAY	1	
LEHİM 1.2	1.2mm. 500Gr. Lehim Teli SOLDEX/FERAY	1	
TÜP LEHİM	1.2mm. Tüp Lehim Teli SOLDEX/FERAY	1	
LHP	50 Gr. Lehim Pastası SOLDEX/LÖTFETT	1	
PC-26	Lehim Suyu FLUX 1LT. SOLDEX	1	
PC-33	Lehim Suyu FLUX 1LT. SOLDEX	1	

KALİTE BELGELERİMİZ



Weiller
XURUI

www.weiller.com.tr
info@weiller.com.tr

